

5

Fornax PvcSecure Kapı Kilit Donanımları

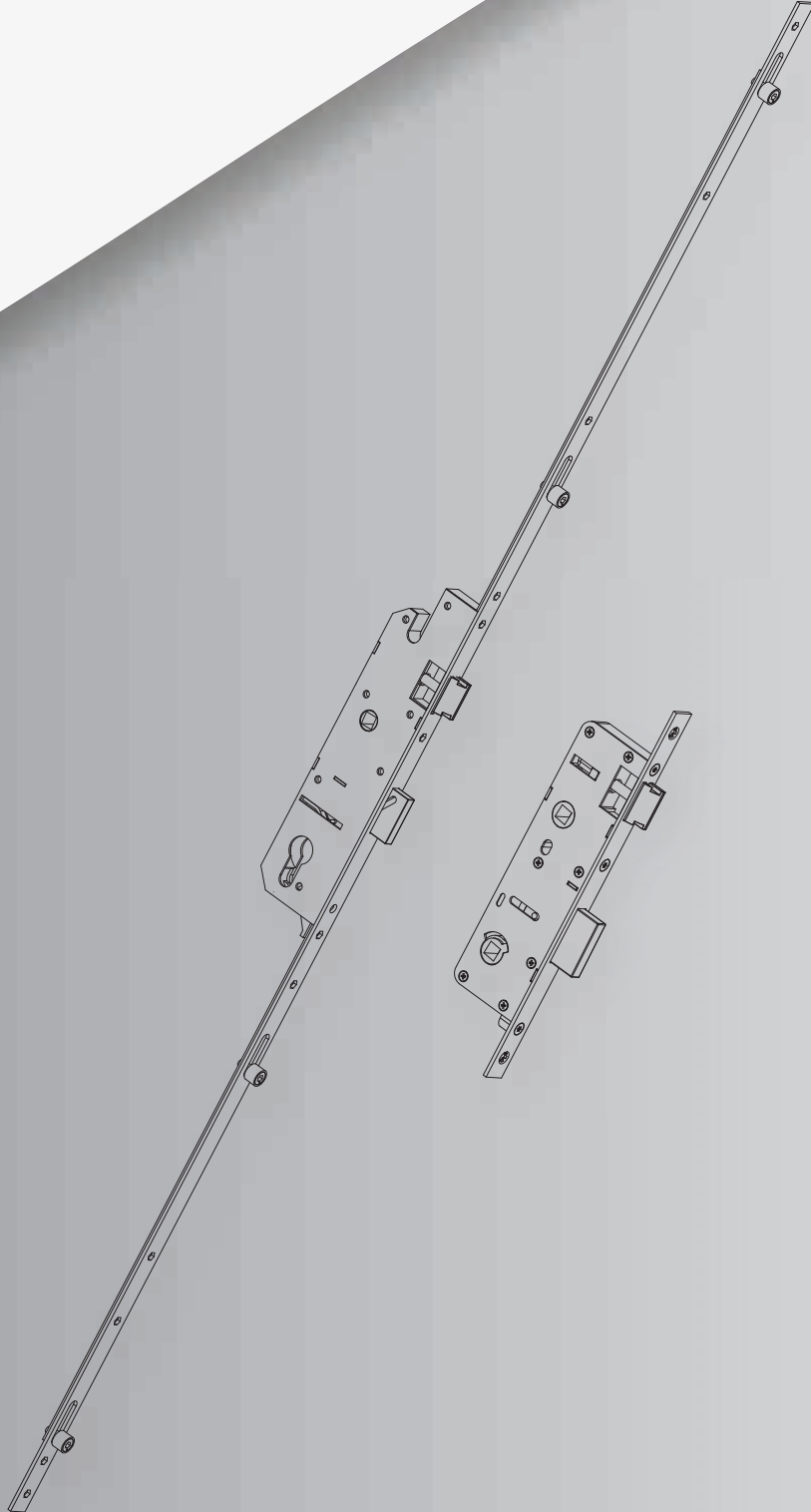



Fornax PvcSecure
Kapı Kilit Donanımları

İÇİNDEKİLER

Gömme Kapı Kilitleri	119
Kilitli Kapı İspanyoletleri	125
Kilit Aksesuarları	143

Fornax PvcSecure
Gömme Kapı Kilitleri
Banyo / Wc

Donanım Teknik Detayları

GT - Gövde Tipi	:	Plastik Gövde - Sac Kapak
Çalışma Şekli	:	Barelden Kumandalı
Kol Merkezi	:	90mm
Eksen	:	20mm - 25mm - 30mm- 35mm 40mm - 45mm

Donanım Açıklaması

- **Montaj ;**
Kolay Montaj ile zaman tasarrufu sağlar.
3,9x25 YHB Seyrek Dişli İspanyolet Vidası Kod: 449.339.025.001

- Kaplama ;**
NanoCoat kaplama ile uzun ömürlü korozyon korumasına sahiptir.

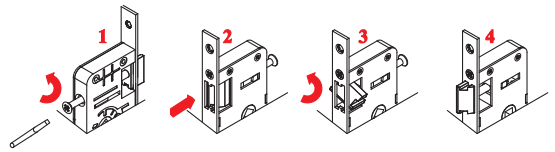
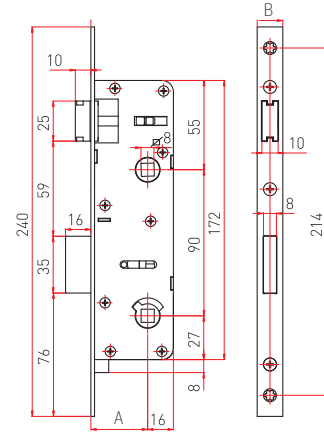
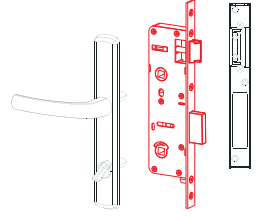

TEKNİK DETAYLARI

A	B	
20	16	2
25	16	2
30	16	2
35	16	2
40	16	2
45	16	2

Not: Teknik detay ölçüleri milimetre (mm) cinsinden verilmiştir.

SİPARİŞ DETAYLARI

		Miktar	Kg
261.090.020.000	90-20 mm Wc / Banyo	40	11.32
261.090.025.000	90-25 mm Wc / Banyo	40	12.60
261.090.030.000	90-30 mm Wc / Banyo	40	13.72
261.090.035.000	90-35 mm Wc / Banyo	40	14.68
261.090.040.000	90-40 mm Wc / Banyo	40	15.20
261.090.045.000	90-45 mm Wc / Banyo	40	-

Fornax PvcSecure
Gömme Kapı Kilitleri
Oda

Donanım Teknik Detayları

GT - Gövde Tipi	:	Plastik Gövde - Sac Kapak
Çalışma Şekli	:	Anahtardan Tahrikli
Kol Merkezi	:	90mm
Eksen	:	20mm - 25mm - 30mm- 35mm 40mm - 45mm

Donanım Açıklaması

- **Montaj ;**
Kolay Montaj ile zaman tasarrufu sağlar.
3,9x25 YHB Seyrek Dişli İspanyollet Vidası Kod: 449.339.025.001

- **Kaplama ;**
NanoCoat kaplama ile uzun ömürlü korozyon korumasına sahiptir.

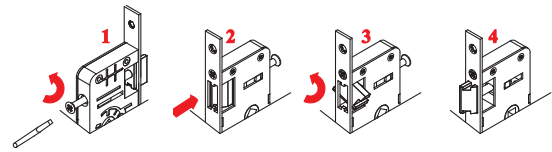
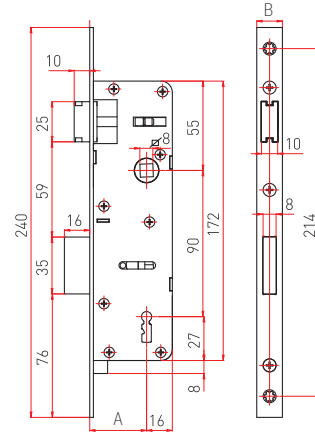
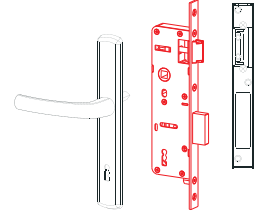

TEKNİK DETAYLARI

A	B	
20	16	2
25	16	2
30	16	2
35	16	2
40	16	2
45	16	2

Not: Teknik detay ölçüleri milimetre (mm) cinsinden verilmiştir.

SİPARİŞ DETAYLARI

		Miktar	Kg
262.090.020.000	90-20 mm Oda	40	11.00
262.090.025.000	90-25 mm Oda	40	12.28
262.090.030.000	90-30 mm Oda	40	13.40
262.090.035.000	90-35 mm Oda	40	14.36
262.090.040.000	90-40 mm Oda	40	15.20
262.090.045.000	90-45 mm Oda	40	-

Fornax PvcSecure
Gömme Kapı Kilitleri
85mm Silindirli

Donanım Teknik Detayları

GT - Gövde Tipi	:	Plastik Gövde - Sac Kapak
Çalışma Şekli	:	Barelden Kumandalı
Kol Merkezi	:	85mm
Eksen	:	20mm - 25mm - 30mm- 35mm 40mm - 45mm

Donanım Açıklaması

- **Montaj ;**
Kolay Montaj ile zaman tasarrufu sağlar.
3,9x25 YHB Seyrek Dişli İspanyolet Vidası Kod: 449.339.025.001

- Kaplama ;**
NanoCoat kaplama ile uzun ömürlü korozyon korumasına sahiptir.

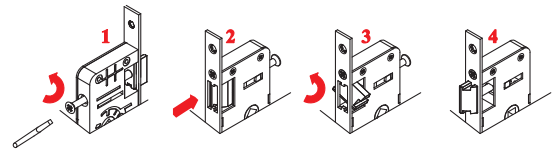
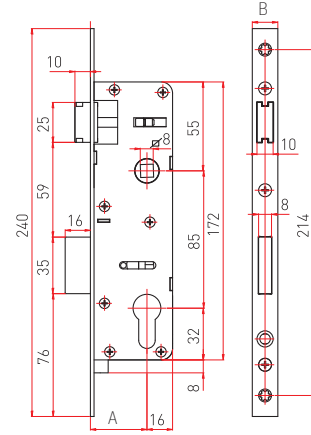
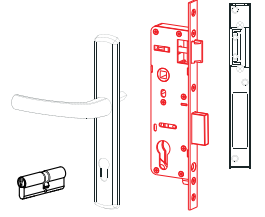

TEKNİK DETAYLARI

A	B	
20	16	2
25	16	2
30	16	2
35	16	2
40	16	2
45	16	2

Not: Teknik detay ölçüleri milimetre (mm) cinsinden verilmiştir.

SİPARİŞ DETAYLARI

		Miktar	Kg
263.085.020.000	85-20 mm Silindirli	40	10.76
263.085.025.000	85-25 mm Silindirli	40	12.04
263.085.030.000	85-30 mm Silindirli	40	13.16
263.085.035.000	85-35 mm Silindirli	40	14.12
263.085.040.000	85-40 mm Silindirli	40	15.25
263.085.045.000	85-45 mm Silindirli	40	-

Fornax PvcSecure
Gömme Kapı Kilitleri
92mm Silindirli

Donanım Teknik Detayları

GT - Gövde Tipi	:	Plastik Gövde - Sac Kapak
Çalışma Şekli	:	Barelden Kumandalı
Kol Merkezi	:	92mm
Eksen	:	20mm - 25mm - 30mm- 35mm

Donanım Açıklaması

- **Montaj ;**
Kolay Montaj ile zaman tasarrufu sağlar.
3,9x25 YHB Seyrek Dişli İspanyolet Vidası Kod: 449.339.025.001
- **Kaplama ;**
NanoCoat kaplama ile uzun ömürlü korozyon korumasına sahiptir.

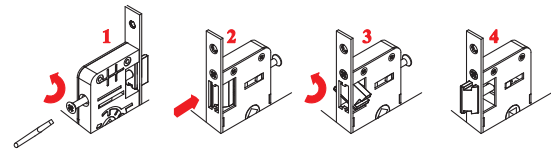
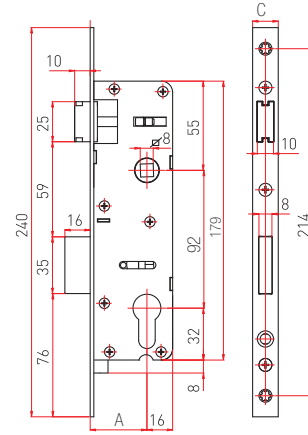
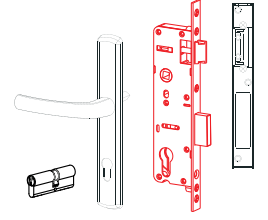

SİPARİŞ DETAYLARI

		Miktar	
		Miktar	Kg
263.092.025.000	92-25 mm Silindirli	40	12.04
263.092.030.000	92-30 mm Silindirli	40	13.16
263.092.035.000	92-35 mm Silindirli	40	14.12
263.092.040.000	92-40 mm Silindirli	40	15.25

TEKNİK DETAYLARI

A	B	
25	16	2
30	16	2
35	16	2
40	16	2

Not: Teknik detay ölçüleri milimetre (mm) cinsinden verilmiştir.

Fornax PvcSecure
Gömme Kapı Kilitleri
Makaralı ve Silindirli

Donanım Teknik Detayları

GT - Gövde Tipi	: Plastik Gövde - Sac Kapak
Çalışma Şekli	: Barelden Kumandalı
Kol Merkezi	: -
Eksen	: 25mm - 30mm - 35mm - 40mm

Donanım Açıklaması

- **Montaj ;**
Kolay Montaj ile zaman tasarrufu sağlar.
3,9x25 YHB Seyrek Dişli İspanyolet Vidası Kod: 449.339.025.001

Kaplama ;
NanoCoat kaplama ile uzun ömürlü korozyon korumasına sahiptir.

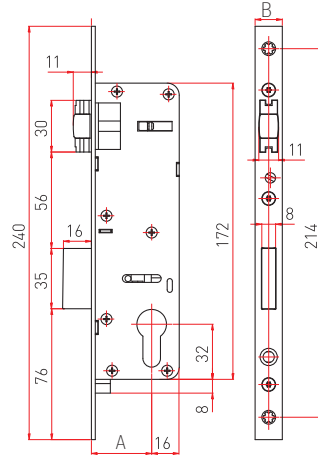
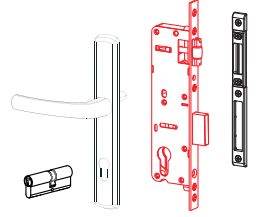

SİPARİŞ DETAYLARI

		Miktar	Kg
263.000.020.000	20 mm Makaralı Silindirli	40	10.76
263.000.025.000	25 mm Makaralı Silindirli	40	12.04
263.000.030.000	30 mm Makaralı Silindirli	40	13.16
263.000.035.000	35 mm Makaralı Silindirli	40	14.12

TEKNİK DETAYLARI

A	B	
20	16	2
25	16	2
30	16	2
35	16	2

Not: Teknik detay ölçüleri milimetre (mm) cinsinden verilmiştir.

Fornax PvcSecure
Kilitli Kapı İspanyoletleri
85/25mm Koldan Kumandalı

Donanım Teknik Detayları

KY - Kanat Yüksekliği	:	1600mm - 2400mm
GT - Gövde Tipi	:	Plastik Gövde - Sac Kapak
Çalışma Şekli	:	Koldan Kumandalı
Kol Merkezi	:	85mm
Eksen	:	25mm

Donanım Açıklaması

- Montaj ;**
Kolay Montaj ile zaman tasarrufu sağlar.
3,9x25 YHB Seyrek Dişli İspanyolet Vidası Kod: 449.339.025.001
- Kaplama ;**
NanoCoat kaplama ile uzun ömürlü korozyon korumasına sahiptir.

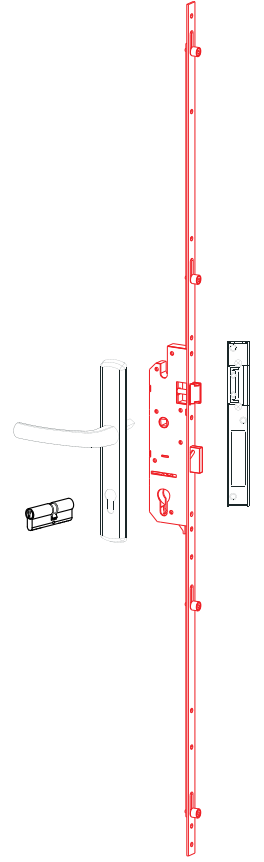

Koldan Kumandalı Çalıştırma Şekli

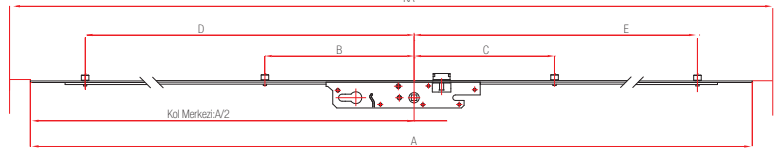
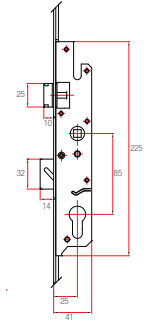
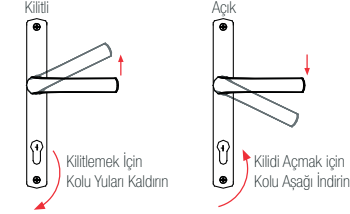

BARELLİ DİLSİZ (B+/D-)

EP	GP	Açıklama	Miktar	Kg
170.160.185.125	170.160.185.225	1600/85/25 (B+/D-)	10	9.74
170.180.185.125	170.180.185.225	1800/85/25 (B+/D-)	10	10.80
170.200.185.125	170.200.185.225	2000/85/25 (B+/D-)	10	11.87

BARELSİZ DİLSİZ (B-/D-)

170.160.285.125	170.160.285.225	1600/85/25 (B-/D-)	10	9.74
170.180.285.125	170.180.285.225	1800/85/25 (B-/D-)	10	10.80
170.200.285.125	170.200.285.225	2000/85/25 (B-/D-)	10	11.87

BARELLİ DİLLİ (B+/D+)

170.160.385.125	170.160.385.225	1600/85/25 (B+/D+)	10	9.74
170.180.385.125	170.180.385.225	1800/85/25 (B+/D+)	10	10.80
170.200.385.125	170.200.385.225	2000/85/25 (B+/D+)	10	11.87

BARELLİ DİLSİZ (B+/D-)

KA	A	B	C	D	E	F		
1600-1800	1600	300	-	806	624	-	11	3
1800-2000	1800	300	308	806	824	-	12	4
2000-2400	2000	300	308	865	885	-	12	4

BARELSİZ DİLSİZ (B-/D-)

1600-1800	1600	300	-	806	624	-	11	3
1800-2000	1800	300	308	806	824	-	12	4
2000-2400	2000	300	308	865	885	-	12	4

BARELLİ DİLLİ (B+/D+)

1600-1800	1600	300	-	806	624	-	11	3
1800-2000	1800	300	308	806	824	-	12	4
2000-2400	2000	300	308	865	885	-	12	4

Not: Teknik detay ölçüleri milimetre (mm) cinsinden verilmiştir.
Tablodaki ölçüler Kilitin Açık Pozisyonu için verilmiştir.

Fornax PvcSecure
Kilitli Kapı İspanyoletleri
85/28mm Koldan Kumandalı

Donanım Teknik Detayları

KY - Kanat Yüksekliği	:	1600mm - 2400mm
GT - Gövde Tipi	:	Plastik Gövde - Sac Kapak
Çalışma Şekli	:	Koldan Kumandalı
Kol Merkezi	:	85mm
Eksen	:	28mm

Donanım Açıklaması

- Montaj ;**
Kolay Montaj ile zaman tasarrufu sağlar.
3,9x25 YHB Seyrek Dişli İspanyolet Vidası Kod: 449.339.025.001
- Kaplama ;**
NanoCoat kaplama ile uzun ömürlü korozyon korumasına sahiptir.

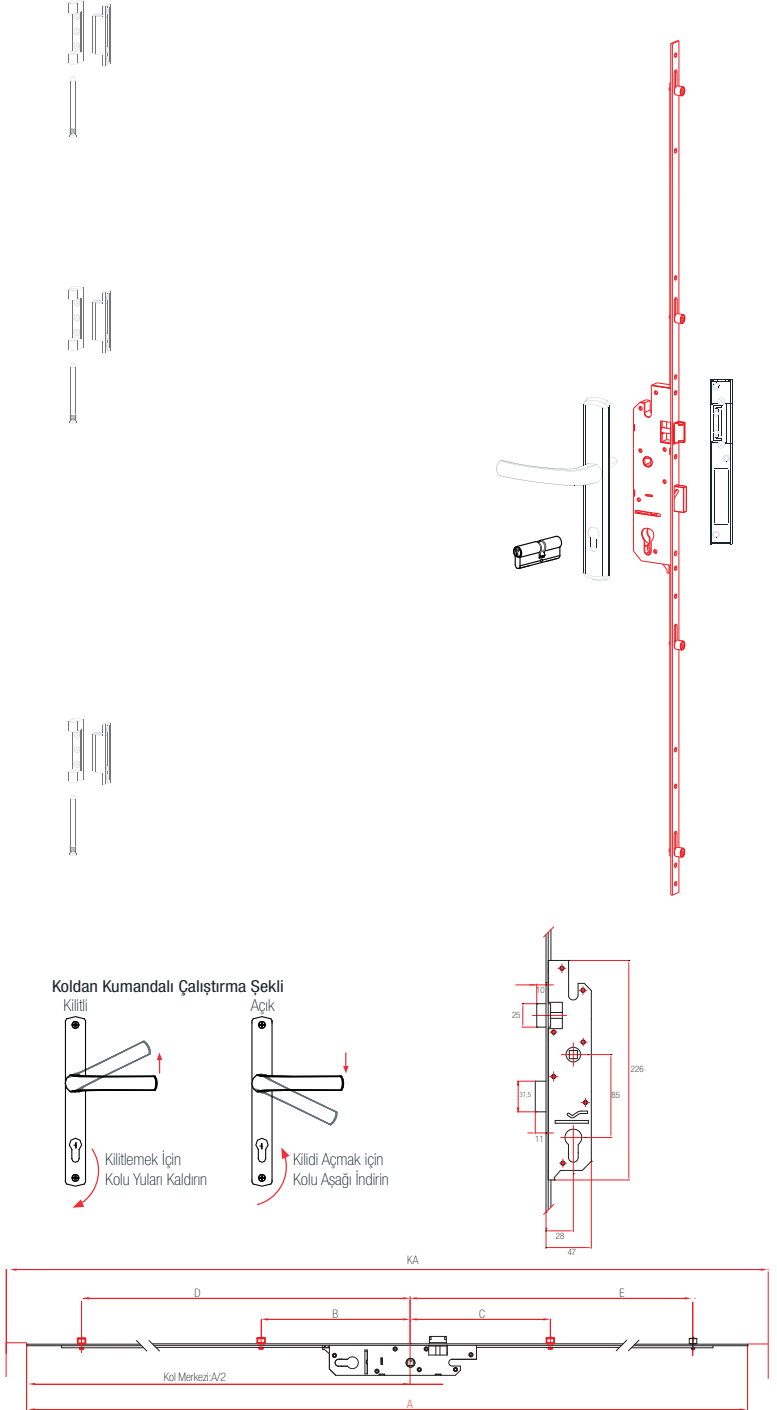

BARELLİ DİLSİZ (B+/D-)

EP	GP	Açıklama	Miktar	Kg
170.160.185.128	170.160.185.228	1600/85/28 (B+/D-)	10	9.74
170.180.185.128	170.180.185.228	1800/85/28 (B+/D-)	10	10.80
170.200.185.128	170.200.185.228	2000/85/28 (B+/D-)	10	11.87

BARELSİZ DİLSİZ (B-/D-)

170.160.285.128	170.160.285.228	1600/85/28 (B-/D-)	10	9.74
170.180.285.128	170.180.285.228	1800/85/28 (B-/D-)	10	10.80
170.200.285.128	170.200.285.228	2000/85/28 (B-/D-)	10	11.87

BARELLİ DİLLİ (B+/D+)

170.160.385.128	170.160.385.228	1600/85/28 (B+/D+)	10	9.74
170.180.385.128	170.180.385.228	1800/85/28 (B+/D+)	10	10.80
170.200.385.128	170.200.385.228	2000/85/28 (B+/D+)	10	11.87

BARELLİ DİLSİZ (B+/D-)

KA	A	B	C	D	E	F		
1600-1800	1600	300	-	806	624	-	11	3
1800-2000	1800	300	308	806	824	-	12	4
2000-2400	2000	300	308	865	885	-	12	4

BARELSİZ DİLSİZ (B-/D-)

1600-1800	1600	300	-	806	624	-	11	3
1800-2000	1800	300	308	806	824	-	12	4
2000-2400	2000	300	308	865	885	-	12	4

BARELLİ DİLLİ (B+/D+)

1600-1800	1600	300	-	806	624	-	11	3
1800-2000	1800	300	308	806	824	-	12	4
2000-2400	2000	300	308	865	885	-	12	4

Not: Teknik detay ölçüleri milimetre (mm) cinsinden verilmiştir.
Tablodaki ölçüler Kilitin Açık Pozisyonu için verilmiştir.

Fornax PvcSecure
Kilitli Kapı İspanyoletleri
85/35mm Koldan Kumandalı

Donanım Teknik Detayları

KY - Kanat Yüksekliği	:	1600mm - 2400mm
GT - Gövde Tipi	:	Plastik Gövde - Sac Kapak
Çalışma Şekli	:	Koldan Kumandalı
Kol Merkezi	:	85mm
Eksen	:	35mm

Donanım Açıklaması

- Montaj ;**
Kolay Montaj ile zaman tasarrufu sağlar.
3,9x25 YHB Seyrek Dişli İspanyolet Vidası Kod: 449.339.025.001
- Kaplama ;**
NanoCoat kaplama ile uzun ömürlü korozyon korumasına sahiptir.

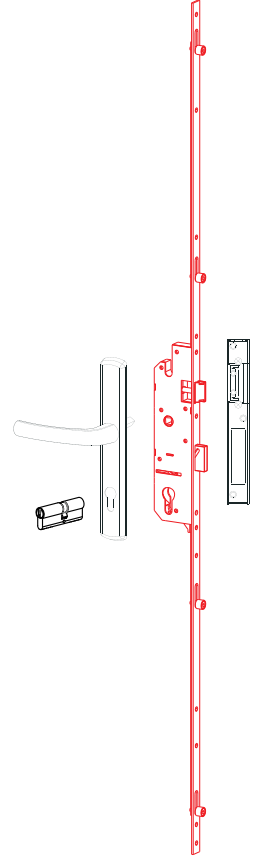

Koldan Kumandalı Çalıştırma Şekli

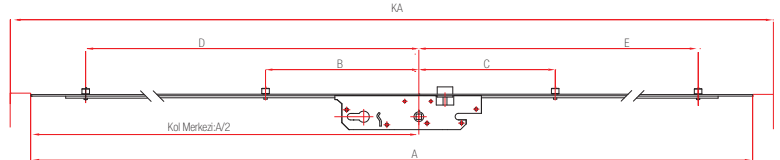
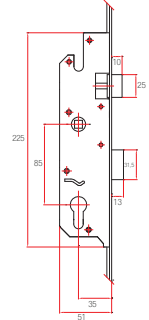
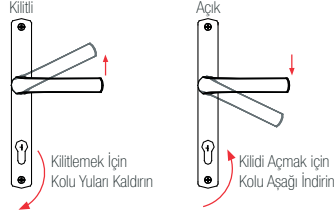

BARELLİ DİLSİZ (B+/D-)

EP	GP	Açıklama	Miktar	Kg
170.160.185.135	170.160.185.235	1600/85/35 (B+/D-)	10	9.74
170.180.185.135	170.180.185.235	1800/85/35(B+/D-)	10	10.80
170.200.185.135	170.200.185.235	2000/85/35 (B+/D-)	10	11.87

BARELSİZ DİLSİZ (B-/D-)

170.160.285.135	170.160.285.235	1600/85/35 (B-/D-)	10	9.74
170.180.285.135	170.180.285.235	1800/85/35 (B-/D-)	10	10.80
170.200.285.135	170.200.285.235	2000/85/35 (B-/D-)	10	11.87

BARELLİ DİLLİ (B+/D+)

170.160.385.135	170.160.385.235	1600/85/35 (B+/D+)	10	9.74
170.180.385.135	170.180.385.235	1800/85/35 (B+/D+)	10	10.80
170.200.385.135	170.200.385.235	2000/85/35 (B+/D+)	10	11.87

BARELLİ DİLSİZ (B+/D-)

KA	A	B	C	D	E	F		
1600-1800	1600	300	-	806	624	-	11	3
1800-2000	1800	300	308	806	824	-	12	4
2000-2400	2000	300	308	865	885	-	12	4

BARELSİZ DİLSİZ (B-/D-)

1600-1800	1600	300	-	806	624	-	11	3
1800-2000	1800	300	308	806	824	-	12	4
2000-2400	2000	300	308	865	885	-	12	4

BARELLİ DİLLİ (B+/D+)

1600-1800	1600	300	-	806	624	-	11	3
1800-2000	1800	300	308	806	824	-	12	4
2000-2400	2000	300	308	865	885	-	12	4

Not: Teknik detay ölçüleri milimetre (mm) cinsinden verilmiştir.
Tablodaki ölçüler Kilitin Açık Pozisyonu için verilmiştir.

Fornax PvcSecure
Kilitli Kapı İspanyoletleri
85/35mm Koldan Kumandalı (Kancalı)

Donanım Teknik Detayları

KY - Kanat Yüksekliği	:	1600mm - 2400mm
GT - Gövde Tipi	:	Plastik Gövde - Sac Kapak
Çalışma Şekli	:	Koldan Kumandalı - Kancalı
Kol Merkezi	:	85mm
Eksen	:	35mm

Donanım Açıklaması

- Montaj ;**
Kolay Montaj ile zaman tasarrufu sağlar.
3,9x25 YHB Seyrek Dişli İspanyolet Vidası Kod: 449.339.025.001
- Kaplama ;**
NanoCoat kaplama ile uzun ömürlü korozyon korumasına sahiptir.

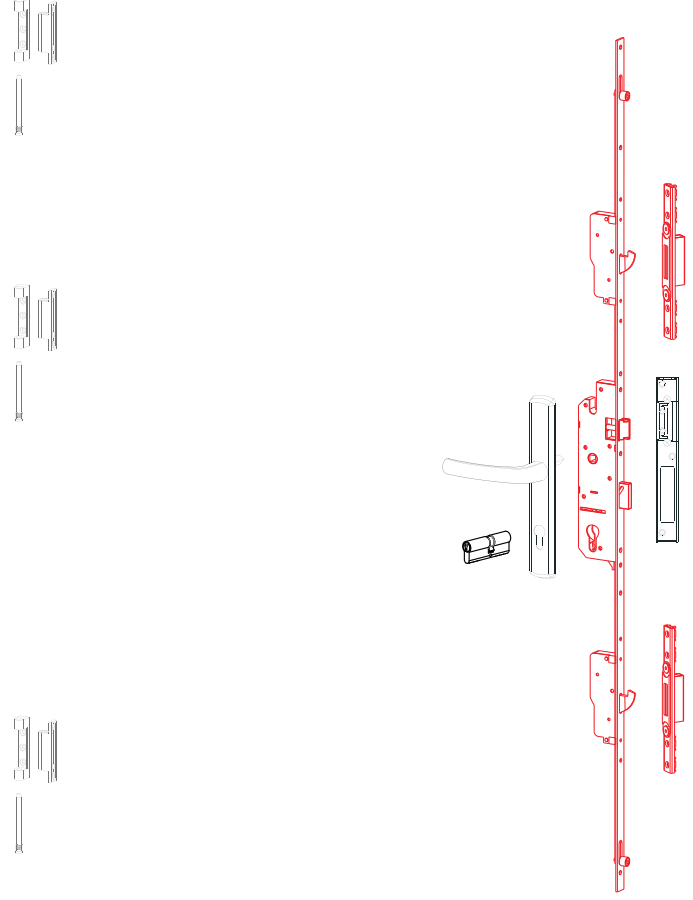

Koldan Kumandalı Çalıştırma Şekli

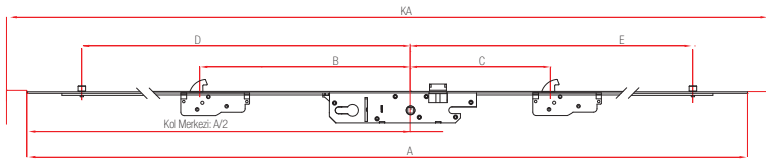
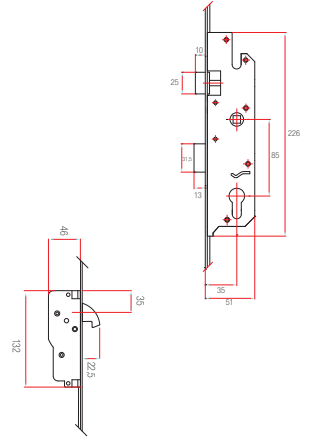
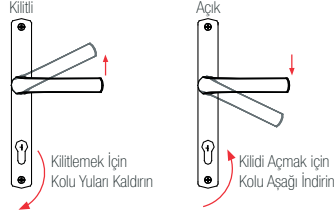

BARELLİ DİLLİ (B+/D+)

EP	GP	Açıklama	Miktar	Kg
171.180.385.135	171.180.385.235	1800/85/35 (B+/D-)	10	11.34
171.200.385.135	171.200.385.235	2000/85/35 (B+/D-)	10	12.41

BARELLİ DİLLİ (B+/D+)

KA	A	B	C	D	E	F		
1800-2000	1800	431	471	748	737	-	12	4
2000-2200	2000	431	471	748	737	-	12	4

Not: Teknik detay ölçüleri milimetre (mm) cinsinden verilmiştir.
Tablodaki Ölçüler Kilitin Açık Pozisyonu için verilmiştir.

Fornax PvcSecure
Kilitli Kapı İspanyoletleri
85/35mm Koldan Kumandalı (İlave Kilitli)

Donanım Teknik Detayları

KY - Kanat Yüksekliği	:	1600mm - 2400mm
GT - Gövde Tipi	:	Plastik Gövde - Sac Kapak
Çalışma Şekli	:	Koldan Kumandalı (İlave Kilitli)
Kol Merkezi	:	85mm
Eksen	:	35mm

Donanım Açıklaması

- Montaj ;**
Kolay Montaj ile zaman tasarrufu sağlar.
3,9x25 YHB Seyrek Dişli İspanyolet Vidası Kod: 449.339.025.001
- Kaplama ;**
NanoCoat kaplama ile uzun ömürlü korozyon korumasına sahiptir.

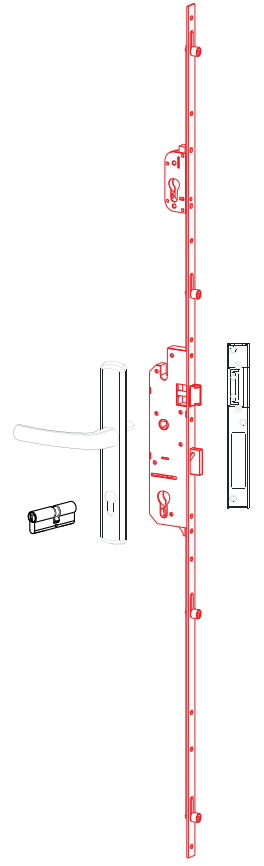

Koldan Kumandalı Çalıştırma Şekli

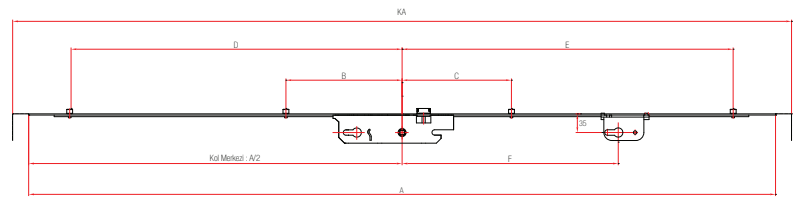
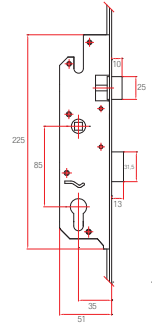
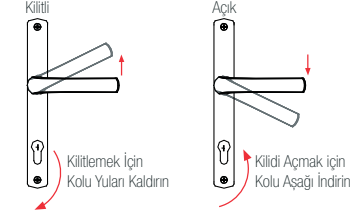

BARELLİ DİLSİZ (B+/D-)

EP	GP	Açıklama	Miktar	Kg
173.160.185.135	170.160.185.235	1600/85/35 (B+/D-)	10	11.17
173.180.185.135	170.180.185.235	1800/85/35(B+/D-)	10	12.23
173.200.185.135	170.200.185.235	2000/85/35 (B+/D-)	10	13.32

BARELSİZ DİLSİZ (B-/D-)

173.160.285.135	170.160.285.235	1600/85/35 (B-/D-)	10	11.17
173.180.285.135	170.180.285.235	1800/85/35 (B-/D-)	10	12.23
173.200.285.135	170.200.285.235	2000/85/35 (B-/D-)	10	13.32

BARELLİ DİLLİ (B+/D+)

173.160.385.135	170.160.385.235	1600/85/35 (B+/D+)	10	11.17
173.180.385.135	170.180.385.235	1800/85/35 (B+/D+)	10	12.23
173.200.385.135	170.200.385.235	2000/85/35 (B+/D+)	10	13.32

BARELLİ DİLSİZ (B+/D-)

KA	A	B	C	D	E	F		
1600-1800	1600	300	-	806	624	614	11	3
1800-2000	1800	300	308	806	824	814	12	4
2000-2400	2000	300	308	865	885	875	12	4

BARELSİZ DİLSİZ (B-/D-)

1600-1800	1600	300	-	806	624	614	11	3
1800-2000	1800	300	308	806	824	814	12	4
2000-2400	2000	300	308	865	885	875	12	4

BARELLİ DİLLİ (B+/D+)

1600-1800	1600	300	-	806	624	614	11	3
1800-2000	1800	300	308	806	824	814	12	4
2000-2400	2000	300	308	865	885	875	12	4

Not: Teknik detay ölçüleri milimetre (mm) cinsinden verilmiştir.
Tablodaki ölçüler Kilitin Açık Pozisyonu için verilmiştir.

Fornax PvcSecure
Kilitli Kapı İspanyoletleri
85/25-28-35mm Koldan Kumandalı (Köşe Bağlantılı)

Donanım Teknik Detayları

KY - Kanat Yüksekliği	:	1600mm - 2400mm
GT - Gövde Tipi	:	Plastik Gövde - Sac Kapak
Çalışma Şekli	:	Koldan Kumandalı- Köşe Bağlantılı
Kol Merkezi	:	85mm
Eksen	:	25-28-35mm

Donanım Açıklaması

- Montaj ;**
Kolay Montaj ile zaman tasarrufu sağlar.
3,9x25 YHB Seyrek Dişli İspanyolet Vidası Kod: 449.339.025.001

- Kaplama ;**
NanoCoat kaplama ile uzun ömürlü korozyon korumasına sahiptir.

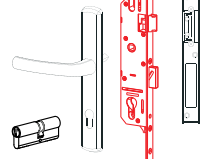

Koldan Kumandalı Çalıştırma Şekli

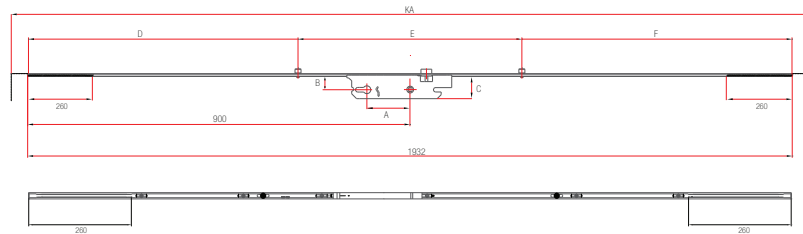
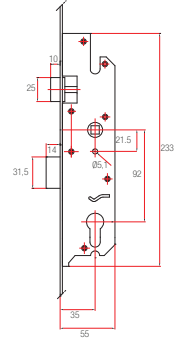
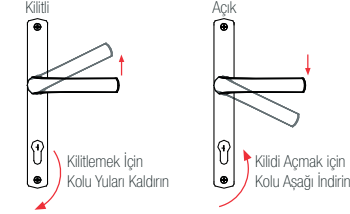

BARELLİ DİLLİ (B+/D+)

EP	GP	Açıklama	Miktar	Kg
170.193.385.125	170.160.192.235	1930/85/25 (B+/D+)	10	11.49
170.193.385.128	170.180.192.235	1930/85/28 (B+/D+)	10	11.91
170.193.385.135	170.200.192.235	1930/85/35 (B+/D+)	10	12.41

BARELLİ DİLSİZ (B+/D-)

KA	A	B	C	D	E	F	Ş	İ
1800-2000	85	25	40	604	744	544	6	2
1800-2000	85	35	47	604	744	544	6	2
1800-2000	85	25	51	604	744	544	6	2

Not: Teknik detay ölçüleri milimetre (mm) cinsinden verilmiştir.
Tablodaki ölçüler Kilitin Açık Pozisyonu için verilmiştir.

Fornax PvcSecure
Kilitli Kapı İspanyoletleri
92/25mm Koldan Kumandalı

Donanım Teknik Detayları

KY - Kanat Yüksekliği	:	1600mm - 2400mm
GT - Gövde Tipi	:	Plastik Gövde - Sac Kapak
Çalışma Şekli	:	Koldan Kumandalı
Kol Merkezi	:	92mm
Eksen	:	25mm

Donanım Açıklaması

- Montaj ;**
Kolay Montaj ile zaman tasarrufu sağlar.
3,9x25 YHB Seyrek Dişli İspanyolet Vidası Kod: 449.339.025.001
- Kaplama ;**
NanoCoat kaplama ile uzun ömürlü korozyon korumasına sahiptir.

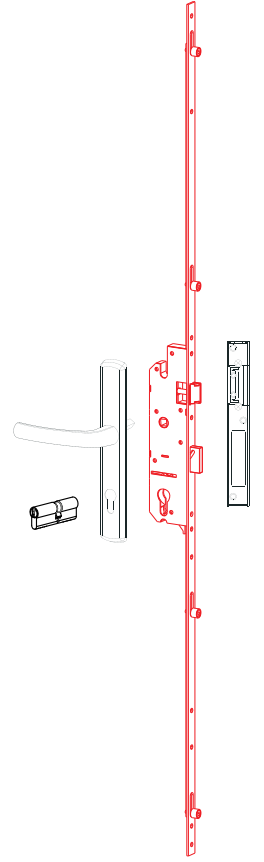

Koldan Kumandalı Çalıştırma Şekli

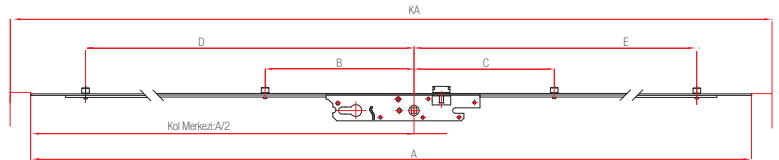
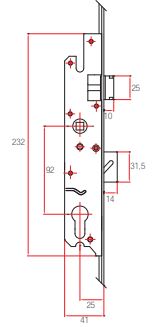
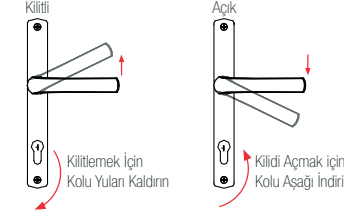

BARELLİ DİLSİZ (B+/D-)

EP	GP	Açıklama	Miktar	Kg
170.160.192.125	170.160.192.225	1600/92/25 (B+/D-)	10	9.74
170.180.192.125	170.180.192.225	1800/92/25 (B+/D-)	10	10.80
170.200.192.125	170.200.192.225	2000/92/25 (B+/D-)	10	11.87

BARELSİZ DİLSİZ (B-/D-)

170.160.292.125	170.160.292.225	1600/92/25 (B-/D-)	10	9.74
170.180.292.125	170.180.292.225	1800/92/25 (B-/D-)	10	10.80
170.200.292.125	170.200.292.225	2000/92/25 (B-/D-)	10	11.87

BARELLİ DİLLİ (B+/D+)

170.160.392.125	170.160.392.225	1600/92/25 (B+/D+)	10	9.74
170.180.392.125	170.180.392.225	1800/92/25 (B+/D+)	10	10.80
170.200.392.125	170.200.392.225	2000/92/25 (B+/D+)	10	11.87

BARELLİ DİLSİZ (B+/D-)

KA	A	B	C	D	E	F		
1600-1800	1600	300	-	806	624	-	11	3
1800-2000	1800	300	308	806	824	-	12	4
2000-2400	2000	300	308	865	885	-	12	4

BARELSİZ DİLSİZ (B-/D-)

1600-1800	1600	300	-	806	624	-	11	3
1800-2000	1800	300	308	806	824	-	12	4
2000-2400	2000	300	308	865	885	-	12	4

BARELLİ DİLLİ (B+/D+)

1600-1800	1600	300	-	806	624	-	11	3
1800-2000	1800	300	308	806	824	-	12	4
2000-2400	2000	300	308	865	885	-	12	4

Not: Teknik detay ölçüleri milimetre (mm) cinsinden verilmiştir.
Tablodaki ölçüler Kilitin Açık Pozisyonu için verilmiştir.

Fornax PvcSecure
Kilitli Kapı İspanyoletleri
92/28mm Koldan Kumandalı

Donanım Teknik Detayları

KY - Kanat Yüksekliği	:	1600mm - 2400mm
GT - Gövde Tipi	:	Plastik Gövde - Sac Kapak
Çalışma Şekli	:	Koldan Kumandalı
Kol Merkezi	:	92mm
Eksen	:	28mm

Donanım Açıklaması

- **Montaj ;**
Kolay Montaj ile zaman tasarrufu sağlar.
3,9x25 YHB Seyrek Dişli İspanyolet Vidası Kod: 449.339.025.001

- Kaplama ;**
NanoCoat kaplama ile uzun ömürlü korozyon korumasına sahiptir.

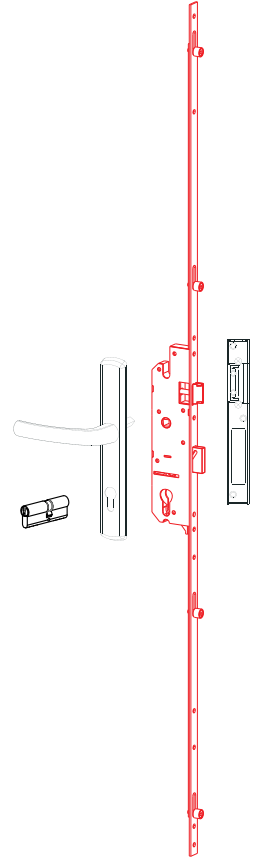

Koldan Kumandalı Çalıştırma Şekli

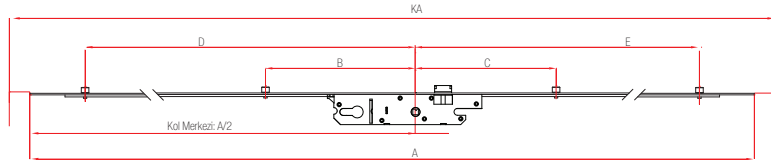
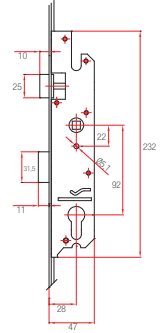
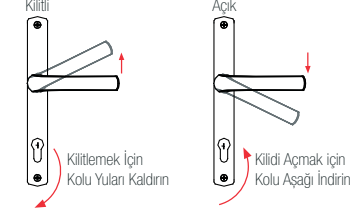

BARELLİ DİLSİZ (B+/D-)

EP	GP	Açıklama	Miktar	Kg
170.160.192.128	170.160.192.228	1600/92/28 (B+/D-)	10	9.74
170.180.192.128	170.180.192.228	1800/92/28 (B+/D-)	10	10.80
170.200.192.128	170.200.192.228	2000/92/28 (B+/D-)	10	11.87

BARELSİZ DİLSİZ (B-/D-)

170.160.292.128	170.160.292.228	1600/92/28 (B-/D-)	10	9.74
170.180.292.128	170.180.292.228	1800/92/28 (B-/D-)	10	10.80
170.200.292.128	170.200.292.228	2000/92/28 (B-/D-)	10	11.87

BARELLİ DİLLİ (B+/D+)

170.160.392.128	170.160.392.228	1600/92/28 (B+/D+)	10	9.74
170.180.392.128	170.180.392.228	1800/92/28 (B+/D+)	10	10.80
170.200.392.128	170.200.392.228	2000/92/28 (B+/D+)	10	11.87

BARELLİ DİLSİZ (B+/D-)

KA	A	B	C	D	E	F		
1600-1800	1600	300	-	806	624	-	11	3
1800-2000	1800	300	308	806	824	-	12	4
2000-2400	2000	300	308	865	885	-	12	4

BARELSİZ DİLSİZ (B-/D-)

1600-1800	1600	300	-	806	624	-	11	3
1800-2000	1800	300	308	806	824	-	12	4
2000-2400	2000	300	308	865	885	-	12	4

BARELLİ DİLLİ (B+/D+)

1600-1800	1600	300	-	806	624	-	11	3
1800-2000	1800	300	308	806	824	-	12	4
2000-2400	2000	300	308	865	885	-	12	4

Not: Teknik detay ölçüleri milimetre (mm) cinsinden verilmiştir.
Tablodaki ölçüler Kilitin Açık Pozisyonu için verilmiştir.

Fornax PvcSecure
Kilitli Kapı İspanyoletleri
92/35mm Koldan Kumandalı

Donanım Teknik Detayları

KY - Kanat Yüksekliği	:	1600mm - 2400mm
GT - Gövde Tipi	:	Plastik Gövde - Sac Kapak
Çalışma Şekli	:	Koldan Kumandalı
Kol Merkezi	:	92mm
Eksen	:	35mm

Donanım Açıklaması

- **Montaj ;**
Kolay Montaj ile zaman tasarrufu sağlar.
3,9x25 YHB Seyrek Dişli İspanyolet Vidası Kod: 449.339.025.001

- Kaplama ;**
NanoCoat kaplama ile uzun ömürlü korozyon korumasına sahiptir.

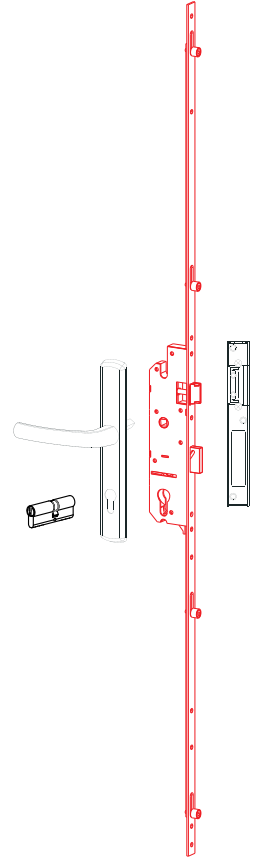

Koldan Kumandalı Çalıştırma Şekli

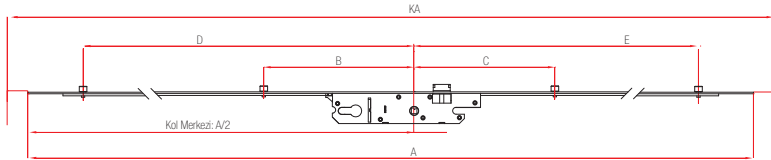
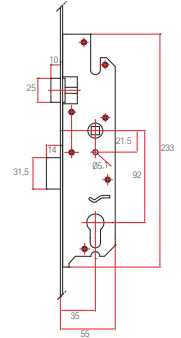
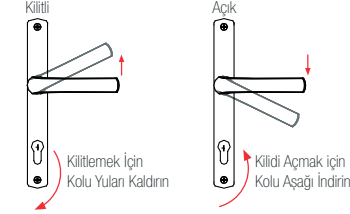

BARELLİ DİLSİZ (B+/D-)

EP	GP	Açıklama	Miktar	Kg
170.160.192.135	170.160.192.235	1600/92/35 (B+/D-)	10	9.74
170.180.192.135	170.180.192.235	1800/92/35 (B+/D-)	10	10.80
170.200.192.135	170.200.192.235	2000/92/35 (B+/D-)	10	11.87

BARELSİZ DİLSİZ (B-/D-)

170.160.292.135	170.160.292.235	1600/92/35 (B-/D-)	10	9.74
170.180.292.135	170.180.292.235	1800/92/35 (B-/D-)	10	10.80
170.200.292.135	170.200.292.235	2000/92/35 (B-/D-)	10	11.87

BARELLİ DİLLİ (B+/D+)

170.160.392.135	170.160.392.235	1600/92/35 (B+/D+)	10	9.74
170.180.392.135	170.180.392.235	1800/92/35 (B+/D+)	10	10.80
170.200.392.135	170.200.392.235	2000/92/35 (B+/D+)	10	11.87

BARELLİ DİLSİZ (B+/D-)

KA	A	B	C	D	E	F		
1600-1800	1600	300	-	806	624	-	11	3
1800-2000	1800	300	308	806	824	-	12	4
2000-2400	2000	300	308	865	885	-	12	4

BARELSİZ DİLSİZ (B-/D-)

1600-1800	1600	300	-	806	624	-	11	3
1800-2000	1800	300	308	806	824	-	12	4
2000-2400	2000	300	308	865	885	-	12	4

BARELLİ DİLLİ (B+/D+)

1600-1800	1600	300	-	806	624	-	11	3
1800-2000	1800	300	308	806	824	-	12	4
2000-2400	2000	300	308	865	885	-	12	4

Not: Teknik detay ölçüleri milimetre (mm) cinsinden verilmiştir.
Tablodaki Ölçüler Kilitin Açık Pozisyonu için verilmiştir.

Fornax PvcSecure
Kilitli Kapı İspanyoletleri
92/35mm Koldan Kumandalı (Kancalı)

Donanım Teknik Detayları

KY - Kanat Yüksekliği	:	1600mm - 2400mm
GT - Gövde Tipi	:	Plastik Gövde - Sac Kapak
Çalışma Şekli	:	Koldan Kumandalı - Kancalı
Kol Merkezi	:	92mm
Eksen	:	35mm

Donanım Açıklaması

- Montaj ;**
Kolay Montaj ile zaman tasarrufu sağlar.
3,9x25 YHB Seyrek Dişli İspanyolet Vidası Kod: 449.339.025.001
- Kaplama ;**
NanoCoat kaplama ile uzun ömürlü korozyon korumasına sahiptir.

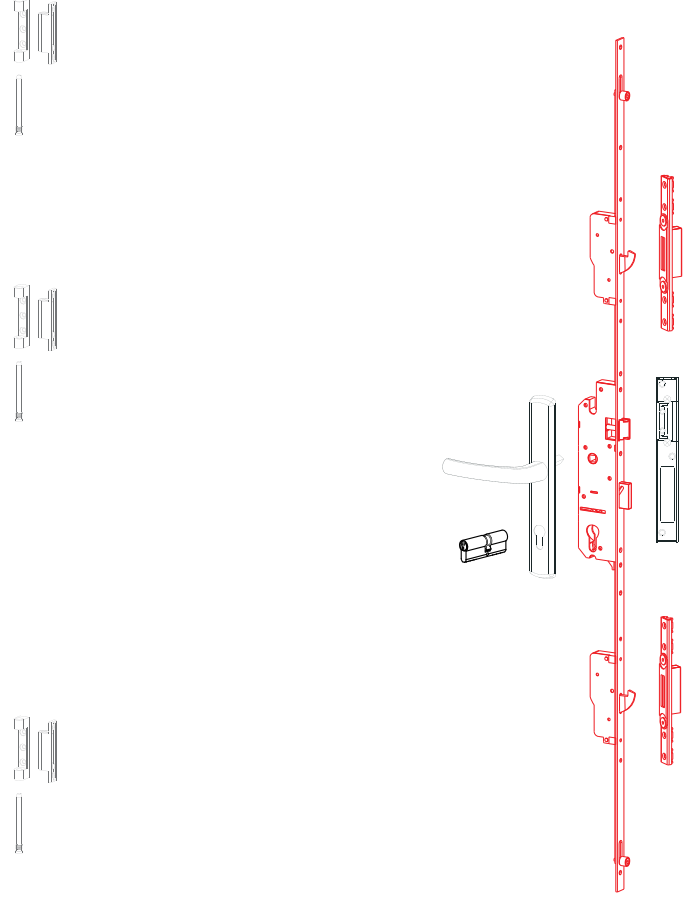

Koldan Kumandalı Çalıştırma Şekli

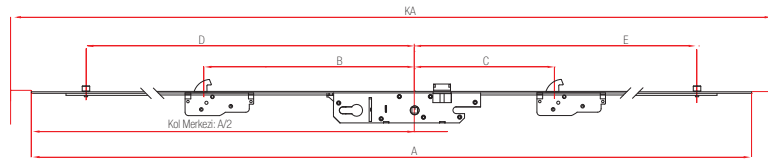
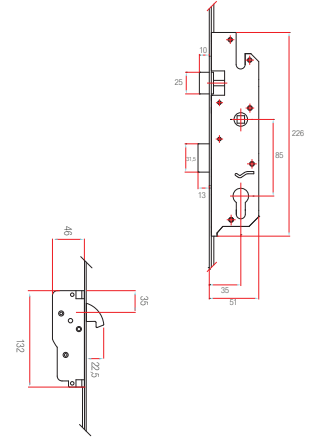
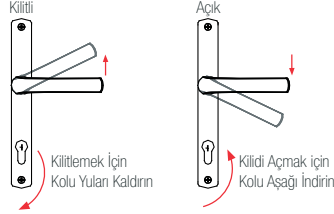

BARELLİ DİLLİ (B+/D+)

EP	GP	Açıklama	Miktar	Kg
171.180.392.135	171.180.392.235	1800/85/35 (B+/D-)	10	11.34
171.200.392.135	171.200.392.235	2000/85/35 (B+/D-)	10	12.41

BARELLİ DİLLİ (B+/D+)

KA	A	B	C	D	E	F		
1800-2000	1800	431	471	748	737	-	12	4
2000-2200	2000	431	471	748	737	-	12	4

Not: Teknik detay ölçüleri milimetre (mm) cinsinden verilmiştir.
Tablodaki ölçüler Kilitin Açık Pozisyonu için verilmiştir.

Fornax PvcSecure
Kilitli Kapı İspanyoletleri
92/25-28-35-45mm Koldan Kumandalı (Köşe Bağlantılı)

Donanım Teknik Detayları

KY - Kanat Yüksekliği	:	1600mm - 2400mm
GT - Gövde Tipi	:	Plastik Gövde - Sac Kapak
Çalışma Şekli	:	Koldan Kumandalı- Köşe Bağlantılı
Kol Merkezi	:	92mm
Eksen	:	25-28-35-45mm

Donanım Açıklaması

- Montaj ;**
Kolay Montaj ile zaman tasarrufu sağlar.
3,9x25 YHB Seyrek Dişli İspanyolet Vidası Kod: 449.339.025.001
- Kaplama ;**
NanoCoat kaplama ile uzun ömürlü korozyon korumasına sahiptir.

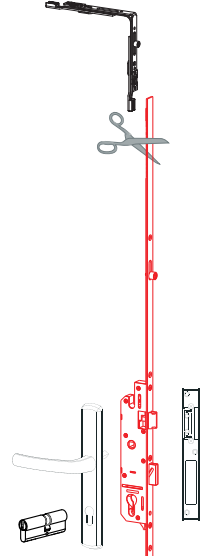

Koldan Kumandalı Çalıştırma Şekli

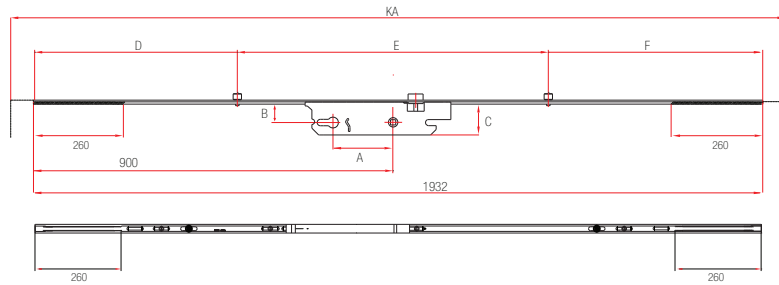
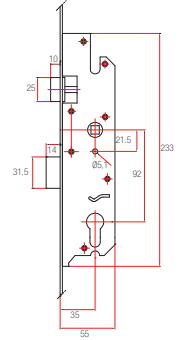
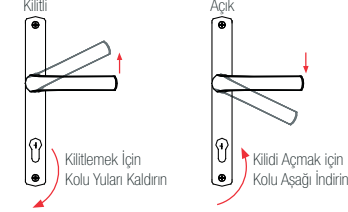

BARELLİ DİLLİ (B+/D+)

EP	GP	Açıklama	Miktar	Kg
170.193.392.125	170.193.392.225	1930/85/25 (B+/D+)	10	11.79
170.193.392.128	170.193.392.228	1930/85/28 (B+/D+)	10	12.21
170.193.392.135	170.193.392.225	1930/85/35 (B+/D+)	10	13.06
170.193.392.145	170.193.392.245	1930/85/45 (B+/D+)	9	12.61

BARELLİ DİLLİ (B+/D+)

KA	A	B	C	D	E	F	🔩	🔩
1800-2000	92	25	40	604	744	544	6	2
1800-2000	92	28	47	604	744	544	6	2
1800-2000	92	35	51	604	744	544	6	2
1800-2000	92	45	51	604	744	544	6	2

Not: Teknik detay ölçüleri milimetre (mm) cinsinden verilmiştir.
Tablodaki ölçüler Kilitin Açık Pozisyonuna için verilmiştir.

Fornax PvcSecure
Kilitli Kapı İspanyoletleri
92/45mm Koldan Kumandalı

Donanım Teknik Detayları

KY - Kanat Yüksekliği	:	1600mm - 2400mm
GT - Gövde Tipi	:	Plastik Gövde - Sac Kapak
Çalışma Şekli	:	Koldan Kumandalı
Kol Merkezi	:	92mm
Eksen	:	45mm

Donanım Açıklaması

- Montaj ;**
Kolay Montaj ile zaman tasarrufu sağlar.
3,9x25 YHB Seyrek Dişli İspanyolet Vidası Kod: 449.339.025.001
- Kaplama ;**
NanoCoat kaplama ile uzun ömürlü korozyon korumasına sahiptir.

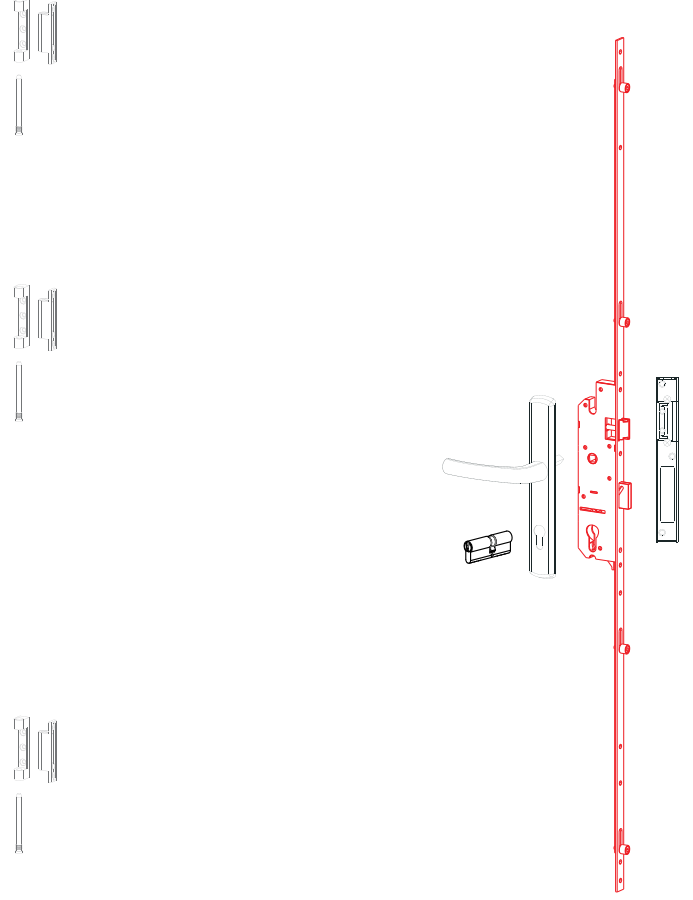

Koldan Kumandalı Çalıştırma Şekli

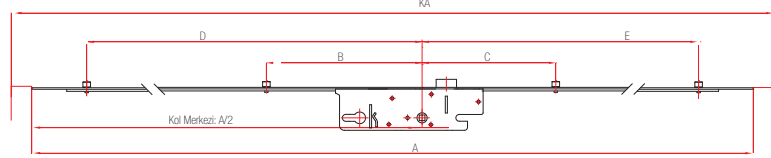
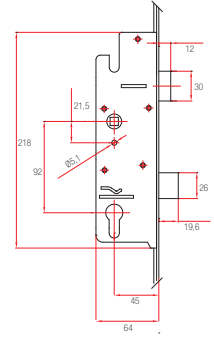
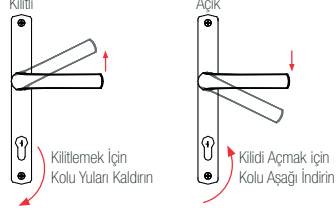

BARELLİ DİLSİZ (B+/D-)

EP	GP	Açıklama	Miktar	Kg
170.160.192.145	170.160.192.245	1600/92/45 (B+/D-)	9	9.74
170.180.192.145	170.180.192.245	1800/92/45 (B+/D-)	9	10.80
170.200.192.145	170.200.192.245	2000/92/45 (B+/D-)	9	11.87

BARELSİZ DİLSİZ (B-/D-)

170.160.292.145	170.160.292.245	1600/92/45 (B-/D-)	9	9.74
170.180.292.145	170.180.292.245	1800/92/45 (B-/D-)	9	10.80
170.200.292.145	170.200.292.245	2000/92/45 (B-/D-)	9	11.87

BARELLİ DİLLİ (B+/D+)

170.160.392.145	170.160.392.245	1600/92/45 (B+/D+)	9	9.74
170.180.392.145	170.180.392.245	1800/92/45 (B+/D+)	9	10.80
170.200.392.145	170.200.392.245	2000/92/45 (B+/D+)	9	11.87

BARELLİ DİLSİZ (B+/D-)

KA	A	B	C	D	E	F		
1600-1800	1600	313	-	818	608	-	11	3
1800-2000	1800	313	294	818	808	-	12	4
2000-2400	2000	313	294	878	869	-	12	4

BARELSİZ DİLSİZ (B-/D-)

1600-1800	1600	313	-	818	608	-	11	3
1800-2000	1800	313	294	818	808	-	12	4
2000-2400	2000	313	294	878	869	-	12	4

BARELLİ DİLLİ (B+/D+)

1600-1800	1600	313	-	818	608	-	11	3
1800-2000	1800	313	294	818	808	-	12	4
2000-2400	2000	313	294	878	869	-	12	4

Not: Teknik detay ölçüleri milimetre (mm) cinsinden verilmiştir.
Tablodaki ölçüler Kilitin Açık Pozisyonu için verilmiştir.

Fornax PvcSecure
Kilitli Kapı İspanyoletleri
92/35mm Barelden Kumandalı

Donanım Teknik Detayları

KY - Kanat Yüksekliği	:	1600mm - 2400mm
GT - Gövde Tipi	:	Zamak Gövde - Sac Kapak
Çalışma Şekli	:	Barelden Kumandalı
Kol Merkezi	:	92mm
Eksen	:	35mm

Donanım Açıklaması

- Montaj ;**
Kolay Montaj ile zaman tasarrufu sağlar.
3,9x25 YHB Seyrek Dişli İspanyolet Vidası Kod: 449.339.025.001
- Kaplama ;**
NanoCoat kaplama ile uzun ömürlü korozyon korumasına sahiptir.

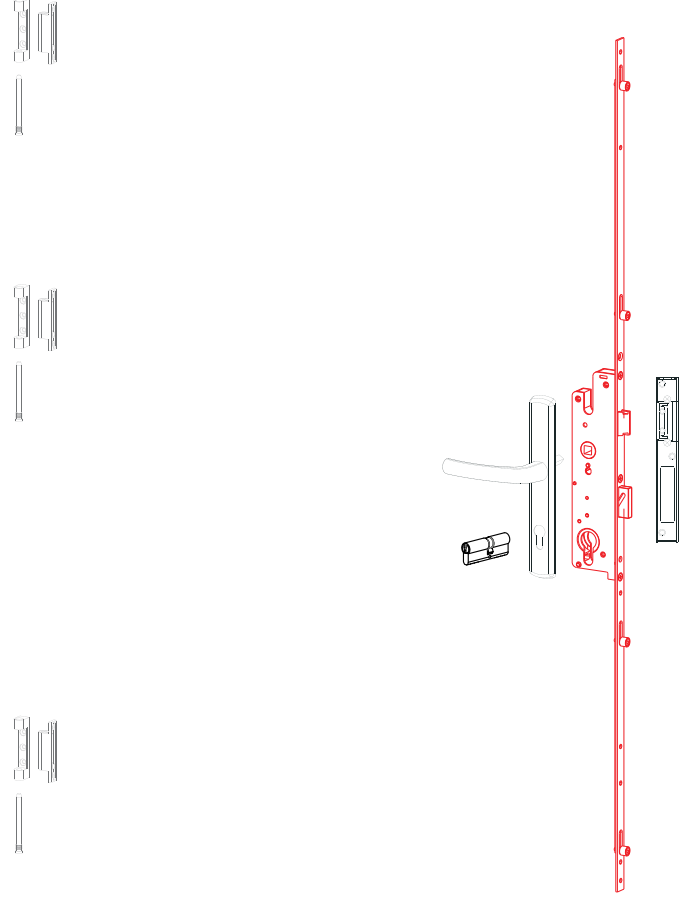

Barelden Kumandalı Çalıştırma Şekli

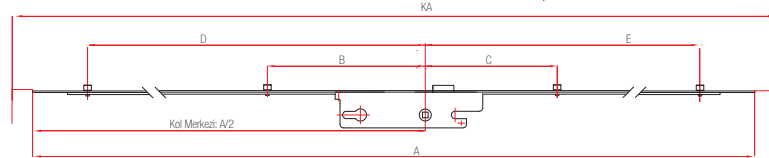
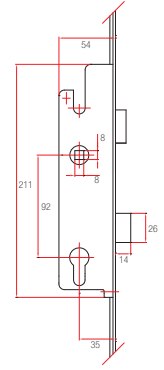
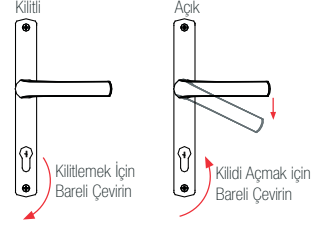

BARELLİ DİLLİ (B+/D+)

EP	GP	Açıklama	Miktar	Kg
160.160.392.135	160.160.392.235	1600/92/35 (B+/D+)	10	13.26
160.160.392.135	160.160.392.235	1600/92/35 (B+/D+)	10	-
160.180.392.135	160.180.392.235	1800/92/35 (B+/D+)	10	13.80
160.200.392.135	160.200.392.235	2000/92/35 (B+/D+)	10	-

BARELLİ DİLLİ (B+/D+)

KA	A	B	C	D	E	F		
1600-1800	1600	299	-	805	623	-	11	3
1600-1800	1600	299	-	805	623	-	11	4
1800-2000	1800	299	307	805	623	-	12	4
2000-2200	2000	395	311	868	885	-	12	4

Not: Teknik detay ölçüleri milimetre (mm) cinsinden verilmiştir.
Tablodaki ölçüler Kilitin Açık Pozisyonu için verilmiştir.

Fornax PvcSecure
Kilitli Kapı İspanyoletleri
92/35mm Barelden Kumandalı (Köşe Bağlantılı)

Donanım Teknik Detayları

KY - Kanat Yüksekliği	:	1600mm - 2400mm
GT - Gövde Tipi	:	Plastik Gövde - Sac Kapak
Çalışma Şekli	:	Barelden Kumandalı- Köşe Bağlantılı
Kol Merkezi	:	92mm
Eksen	:	35mm

Donanım Açıklaması

- **Montaj ;**
Kolay Montaj ile zaman tasarrufu sağlar.
3,9x25 YHB Seyrek Dişli İspanyolet Vidası Kod: 449.339.025.001

- Kaplama ;**
NanoCoat kaplama ile uzun ömürlü korozyon korumasına sahiptir.

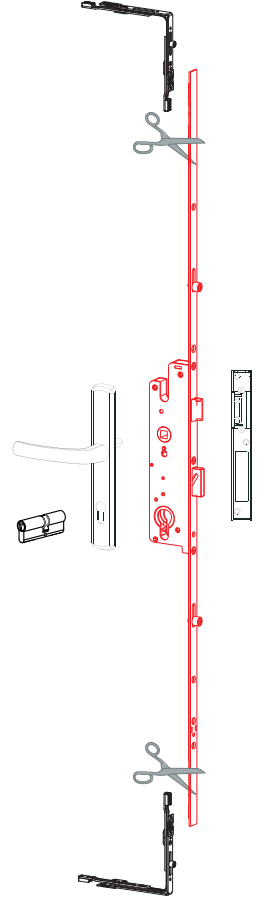

Koldan Kumandalı Çalıştırma Şekli

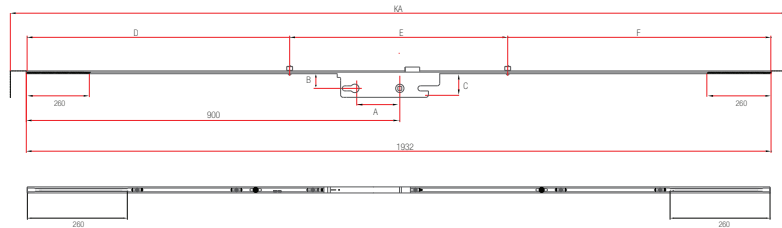
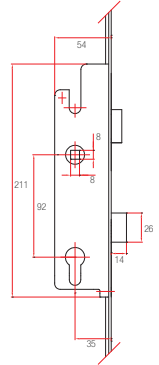
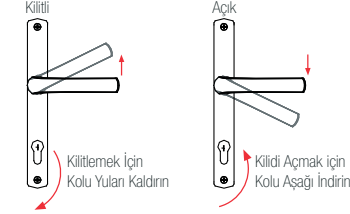

BARELLİ DİLLİ (B+/D+)

EP	GP	Açıklama	Miktar	Kg
165.193.392.135	165.193.392.235	1930/92/35 (B+/D+)	10	14.59

BARELLİ DİLLİ (B+/D+)

KA	A	B	C	D	E	F		
1800-2000	92	299	53	594	744	-	2	2

Not: Teknik detay ölçüleri milimetre (mm) cinsinden verilmiştir.
Tablodaki ölçüler Kilitin Açık Pozisyonu için verilmiştir.

Fornax PvcSecure
Kilitli Kapı İspanyoletleri
92/35mm Barelden Kumandalı (Küçük Kancalı)

Donanım Teknik Detayları

KY - Kanat Yüksekliği	:	1600mm - 2400mm
GT - Gövde Tipi	:	Plastik Gövde - Sac Kapak
Çalışma Şekli	:	Barelden Kumandalı- Küçük Kancalı
Kol Merkezi	:	92mm
Eksen	:	35mm

Donanım Açıklaması

- Montaj ;**
Kolay Montaj ile zaman tasarrufu sağlar.
3,9x25 YHB Seyrek Dişli İspanyolet Vidası Kod: 449.339.025.001
- Kaplama ;**
NanoCoat kaplama ile uzun ömürlü korozyon korumasına sahiptir.

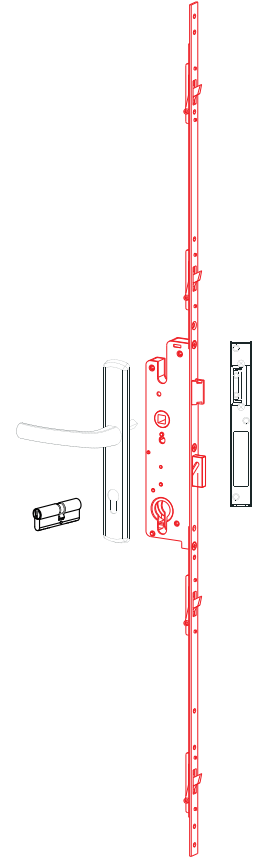

Koldan Kumandalı Çalıştırma Şekli

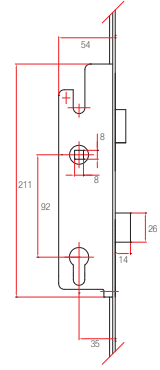
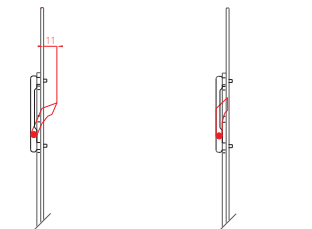
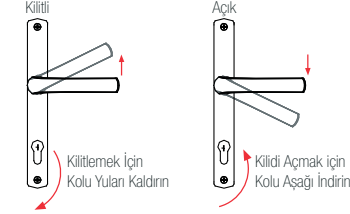

B - Kanca Kilitleme Pozisyonu A - Kanca Açık Pozisyonu

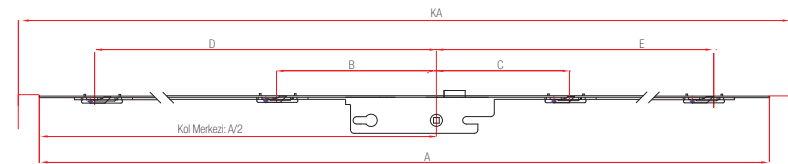

BARELLİ DİLLİ (B+/D+)

	Açıklama	Miktar	Kg
162.208.392.035	2008/92/35 (B+/D+)	10	14.59

BARELLİ DİLLİ (B+/D+)

KA	A	B	C	D	E	F		
1600-2000	2008	316	316	632	632	-	13	3

Not: Teknik detay ölçüleri milimetre (mm) cinsinden verilmiştir.
Tablodaki Ölçüler Kilitin Açık Pozisyonu için verilmiştir.

Fornax PvcSecure
Kilitli Kapı İspanyoletleri
92/35mm Barelden Kumandalı (Kancalı)

Donanım Teknik Detayları

KY - Kanat Yüksekliği	:	1600mm - 2400mm
GT - Gövde Tipi	:	Plastik Gövde - Sac Kapak
Çalışma Şekli	:	Barelden Kumandalı - Kancalı
Kol Merkezi	:	92mm
Eksen	:	35mm

Donanım Açıklaması

- **Montaj ;**
Kolay Montaj ile zaman tasarrufu sağlar.
3,9x25 YHB Seyrek Dişli İspanyolet Vidası Kod: 449.339.025.001

- Kaplama ;**
NanoCoat kaplama ile uzun ömürlü korozyon korumasına sahiptir.

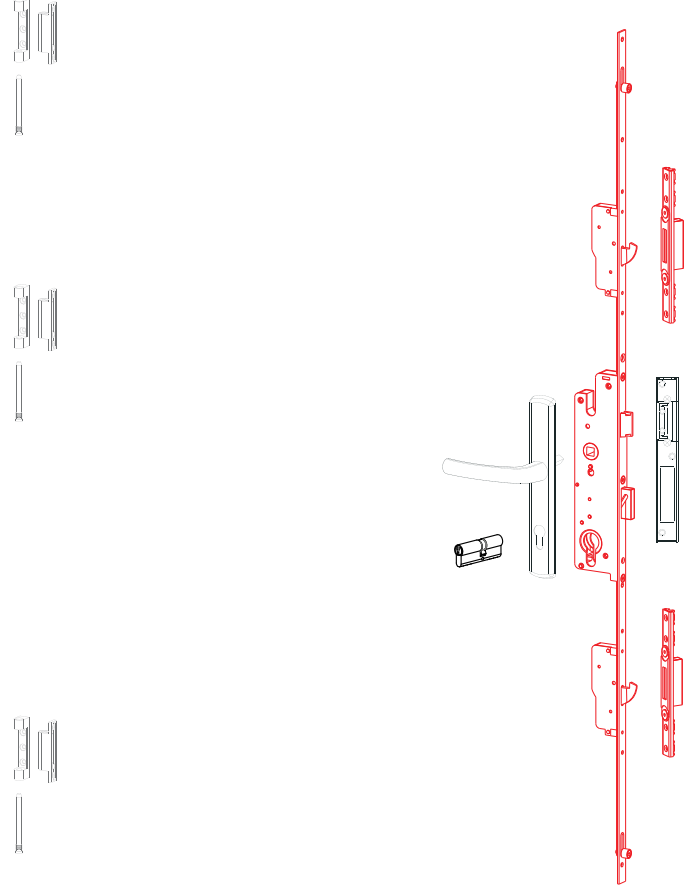

Koldan Kumandalı Çalıştırma Şekli

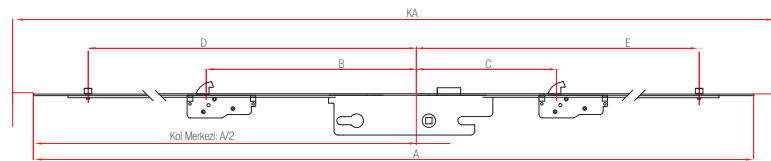
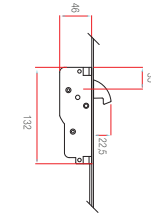
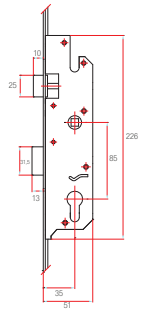
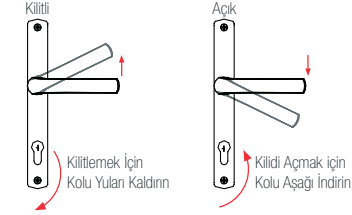

BARELLİ DİLLİ (B+/D+)

EP	GP	Açıklama	Miktar	Kg
161.180.392.135	161.180.395.235	1800/92/35 (B+/D-)	10	13.80
161.200.392.135	161.200.395.235	2000/92/35 (B+/D-)	10	14.64

BARELLİ DİLLİ (B+/D+)

KA	A	B	C	D	E	F		
1800-2000	1800	431	471	748	737	-	12	4
2000-2200	2000	431	471	748	737	-	12	4

Not: Teknik detay ölçüleri milimetre (mm) cinsinden verilmiştir.
Tablodaki ölçüler Kilitin Açık Pozisyonu için verilmiştir.

Fornax PvcSecure
Kilitli Kapı İspanyoletleri
85/35mm Barelden Kumandalı (İlave Kilitli)

Donanım Teknik Detayları

KY - Kanat Yüksekliği	:	1600mm - 2400mm
GT - Gövde Tipi	:	Plastik Gövde - Sac Kapak
Çalışma Şekli	:	Barelden Kumandalı (İlave Kilitli)
Kol Merkezi	:	92mm
Eksen	:	35mm

Donanım Açıklaması

- Montaj ;**
Kolay Montaj ile zaman tasarrufu sağlar.
3,9x25 YHB Seyrek Dişli İspanyolet Vidası Kod: 449.339.025.001
- Kaplama ;**
NanoCoat kaplama ile uzun ömürlü korozyon korumasına sahiptir.

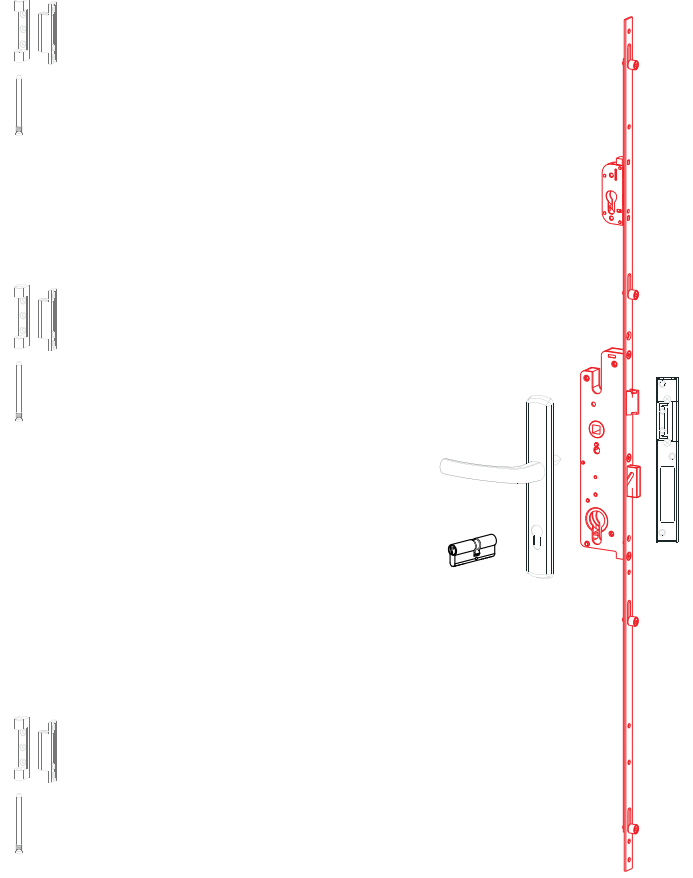

Barelden Kumandalı Çalıştırma Şekli

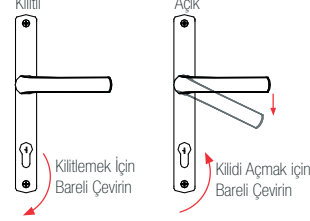

Kilitli
Kilitlemek için
Bareli Çevirin

Açık
Kilidi Açmak için
Bareli Çevirin

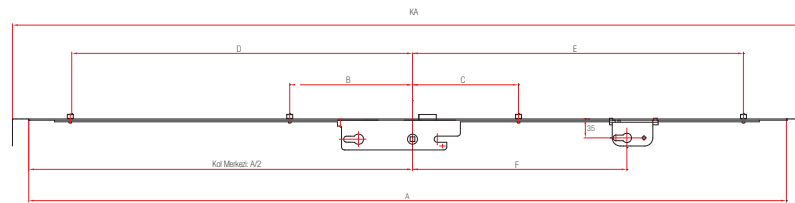
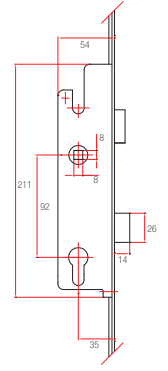

BARELLİ DİLLİ (B+/D+)

EP	GP	Açıklama	Miktar	Kg
163.160.392.135	163.160.392.235	1600/92/35 (B+/D+)	10	14.15
163.180.392.135	163.180.392.235	1800/92/35 (B+/D+)	10	13.80
163.200.392.135	163.200.392.235	2000/92/35 (B+/D+)	10	14.64

BARELLİ DİLLİ (B+/D+)

KA	A	B	C	D	E	F		
1600-1800	1600	308	-	814	614	405	11	3
1800-2000	1800	308	292	814	614	405	12	4
2000-2200	2000	308	302	875	875	458	12	4

Not: Teknik detay ölçüleri milimetre (mm) cinsinden verilmiştir.
Tablodaki ölçüler Kilitin Açık Pozisyonu için verilmiştir.

Fornax PvcSecure
Kilitli Kapı İspanyoletleri
92/35mm Barelden Kumandalı

Donanım Teknik Detayları

KY - Kanat Yüksekliği	:	1600mm - 2400mm
GT - Gövde Tipi	:	Zamak Gövde - Sac Kapak
Çalışma Şekli	:	Barelden Kumandalı
Kol Merkezi	:	92mm
Eksen	:	35mm

Donanım Açıklaması

- Montaj ;**
Kolay Montaj ile zaman tasarrufu sağlar.
3,9x25 YHB Seyrek Dişli İspanyolet Vidası Kod: 449.339.025.001
- Kaplama ;**
NanoCoat kaplama ile uzun ömürlü korozyon korumasına sahiptir.

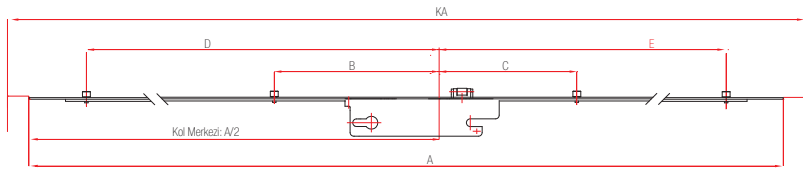
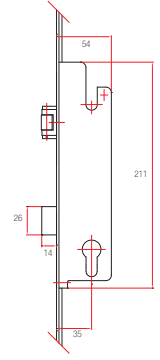
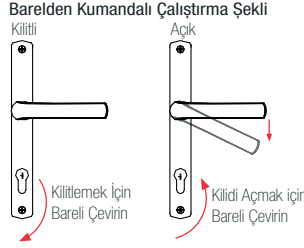
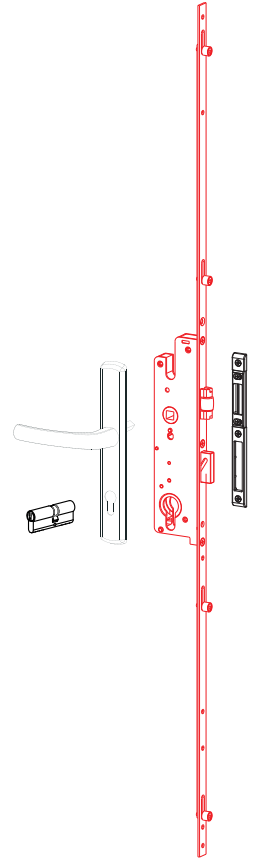

BARELLİ DİLLİ (B+/D+)

EP	GP	Açıklama	Miktar	Kg
169.160.392.135	169.160.392.235	1600/92/35 (B+/D+)	10	14.15
169.180.392.135	169.180.392.235	1800/92/35 (B+/D+)	10	13.80
169.200.392.135	169.200.392.235	2000/92/35 (B+/D+)	10	14.64

BARELLİ DİLLİ (B+/D+)

KA	A	B	C	D	E	F		
1600-1800	1600	299	805	623	-	11	3	
1800-2000	1800	299	307	805	623	-	12	4
2000-2200	2000	295	311	868	885	-	12	4

Not: Teknik detay ölçüleri milimetre (mm) cinsinden verilmiştir.
Tablodaki ölçüler Kilitin Açık Pozisyonu için verilmiştir.

Fornax PvcSecure
Kilit ve Kilitli İspanyolet
Aksesuarları

499.002.068.101

68mm Barel

120

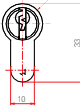
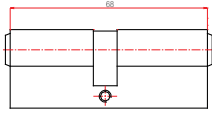
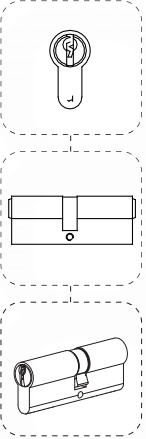

499.002.083.101

83mm Barel

120

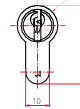
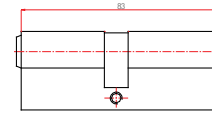
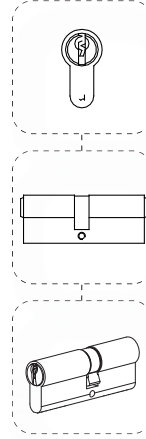

499.002.090.101

90mm Barel

120

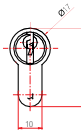
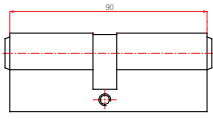
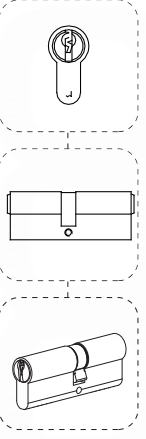

499.002.100.101

100mm Barel

120

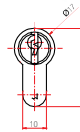
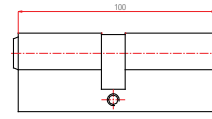
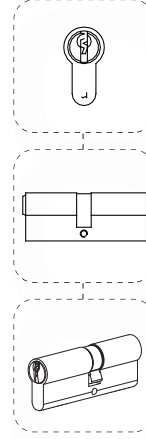

221.006.000.000

Kısa Sac Ayarlı Kilit Karşılığı

250

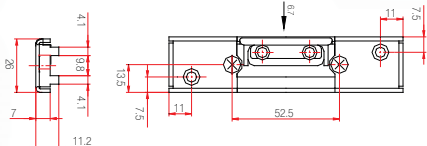
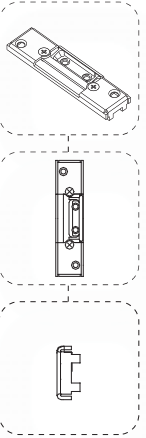

221.006.0001.000

Kısa Zamak Ayarlı Kilit Karşılığı

250

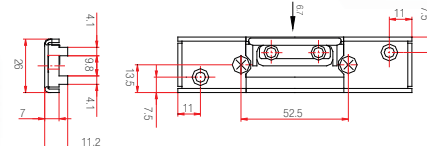
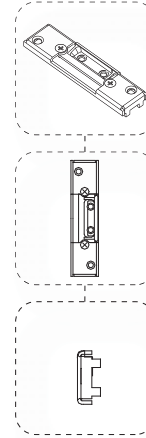

Fornax PvcSecure
Kilit ve Kilitli İspanyolet
Aksesuarları

221.006.002.300

Kısa Zamak Ayarlı Kilit Karşılığı (Sağ/Sol)

250

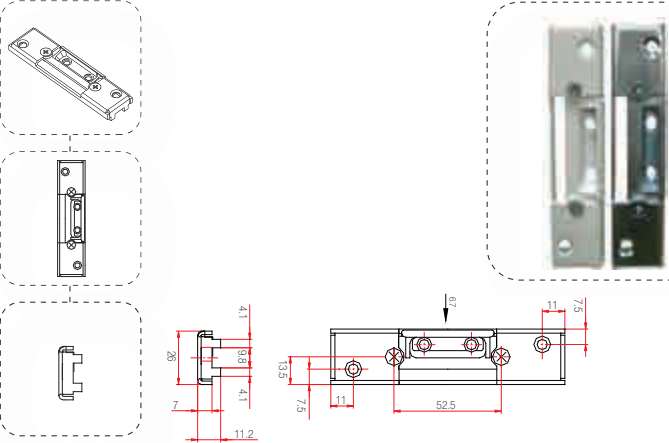

221.006.003.000

Ayarlı Kilit Karşılığı Sağ/Sol (Sac Kalınlığı :1.5mm)

100

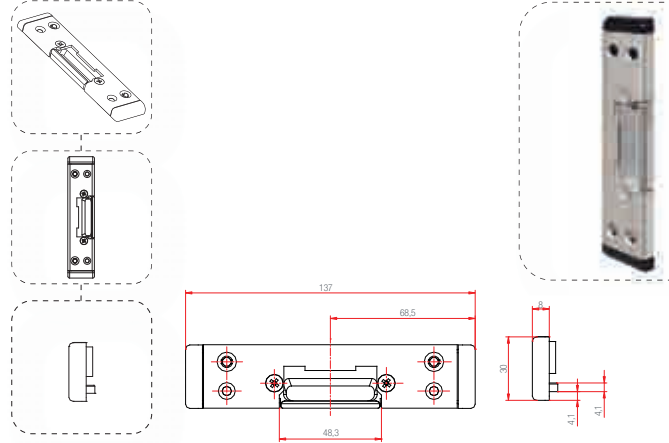

221.006.004.000

Ayarlı Kilit Karşılığı Sağ/Sol (Sac Kalınlığı :2mm)

100

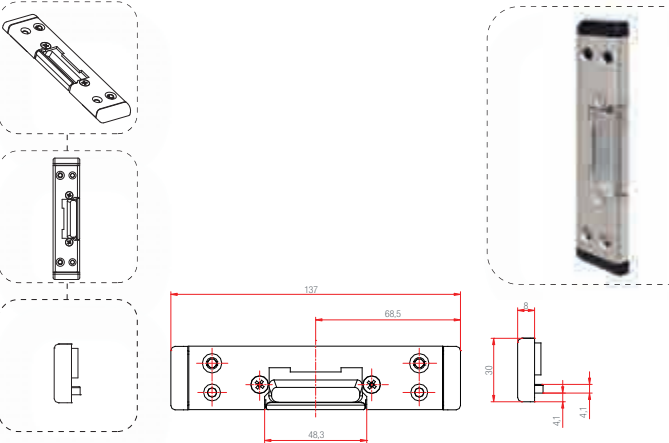

221.007.000.000

Uzun Sac Ayarlı Kilit Karşılığı

100

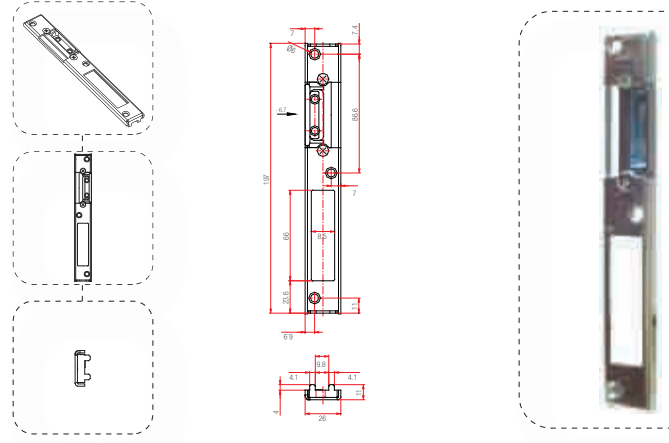

221.007.001.000

Uzun Zamak Ayarlı Kilit Karşılığı

100

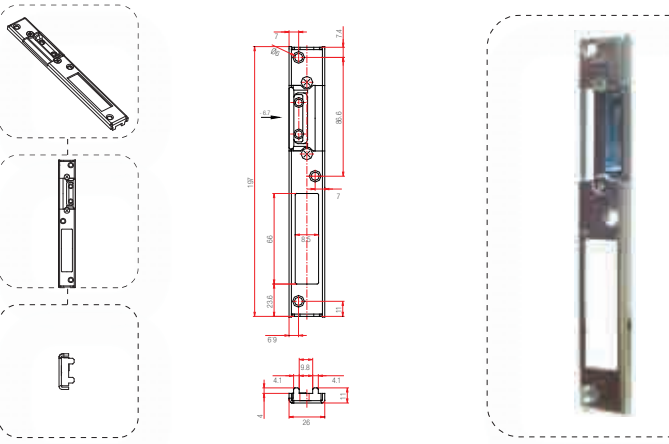

221.007.002.300

Uzun Zamak Ayarlı Kilit Karşılığı (Sağ/Sol)

100

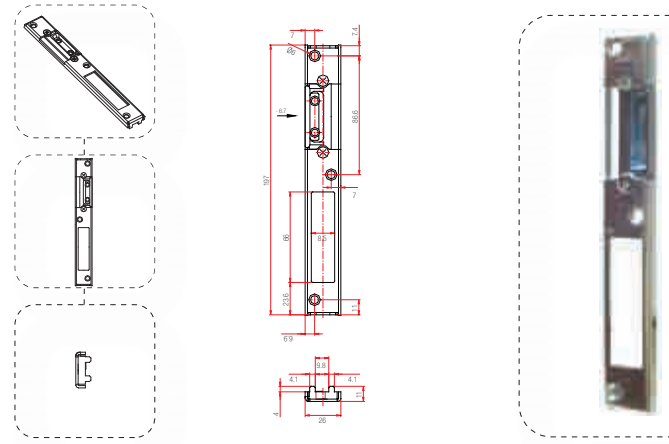

Fornax PvcSecure
Kilit ve Kilitli İspanyolet
Aksesuarları

221.007.200.100

Uzun Ayarlı Kilit Karşılığı (Sağ)

100

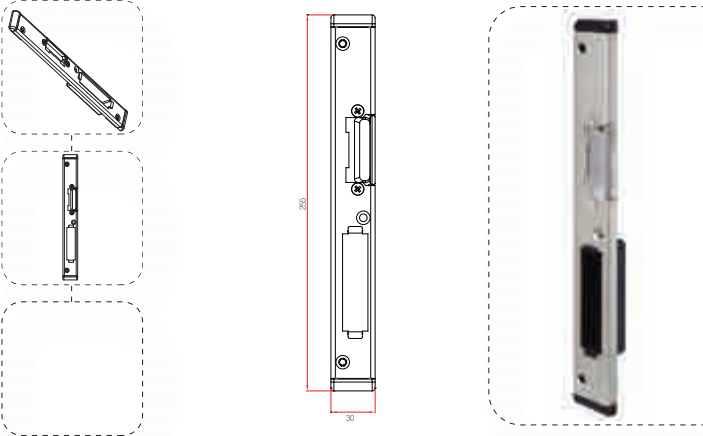

221.007.200.200

Uzun Ayarlı Kilit Karşılığı (Sol)

100

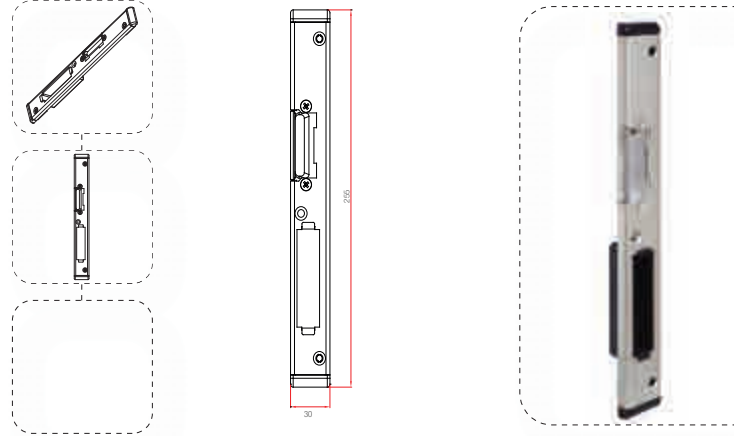

221.010.001.100

Universal Uzun Ayarlı Kilit Karşılığı

100

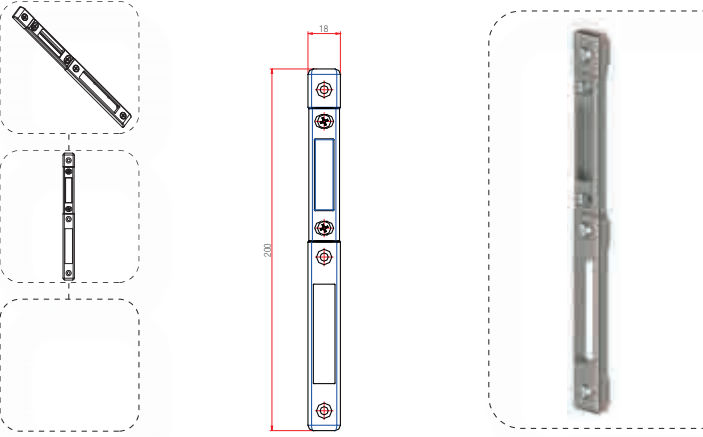

221.007.110.000

Küçük Pls Hazneli Sac Uzun Ayarlı Kilit Karşılığı

100

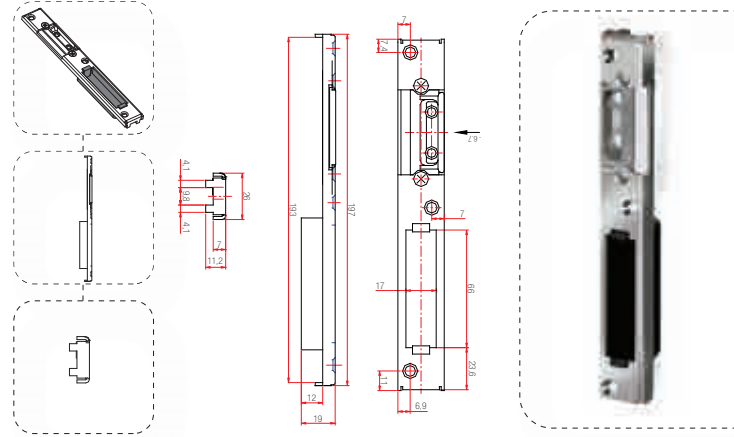

221.007.111.000

Küçük Pls Hazneli Zamak Uzun Ayarlı Kilit Karşılığı

250

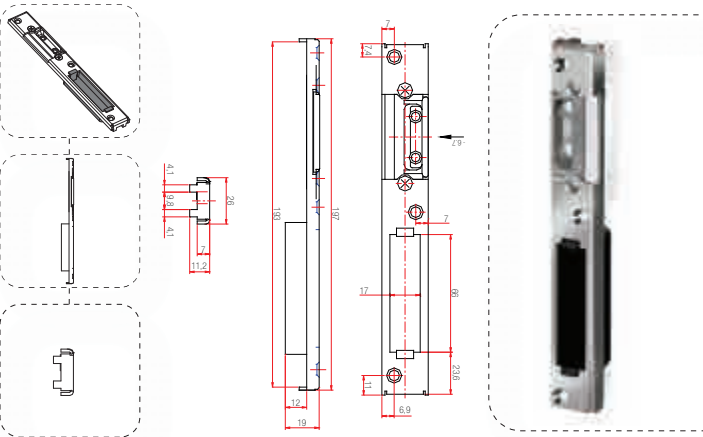

221.007.112.300

Küçük Pls. Hazneli R/L Zamak Uzun Ayarlı Kilit Karşılığı

100

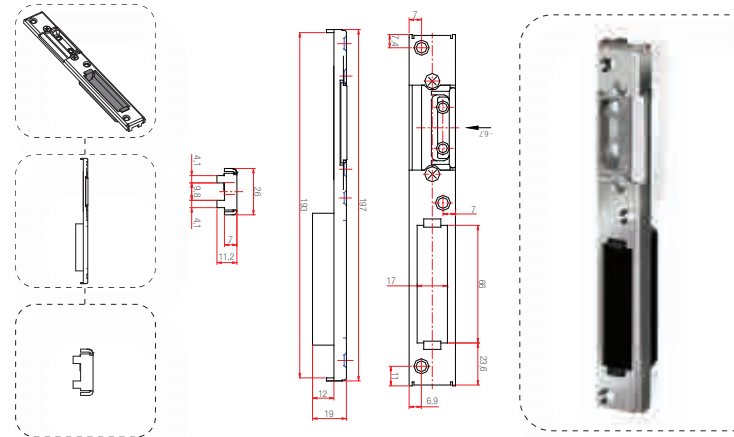

Fornax PvcSecure
Kilit ve Kilitli İspanyolet
Aksesuarları

221.007.100.000

Büyük Pls. Hazneli Sac Zamak Ayarlı Kilit Karşılığı 100 

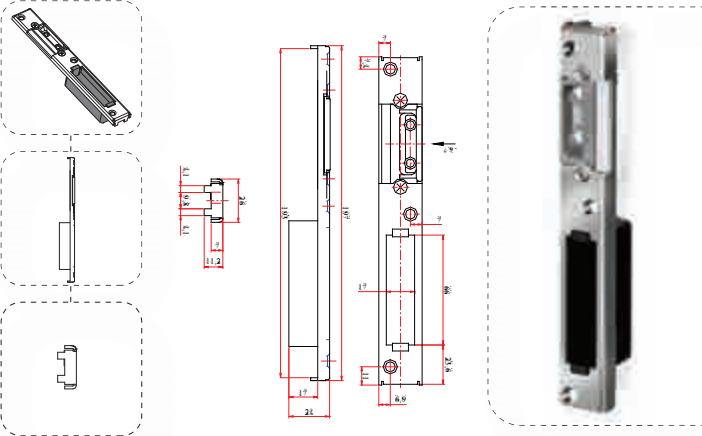

221.007.101.000

Büyük Pls. Hazneli Uzun Zamak Ayarlı Kilit Karşılığı 100 

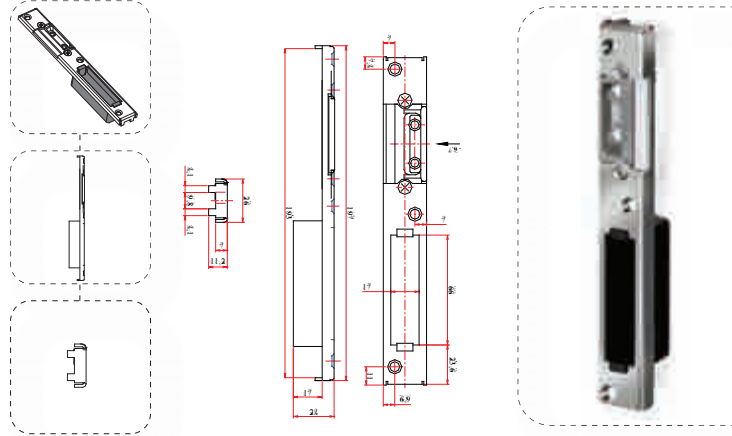

221.007.102.300

Büyük Pls. Hazneli R/L Uzun Zamak Ayarlı Kilit Karşılığı 100 

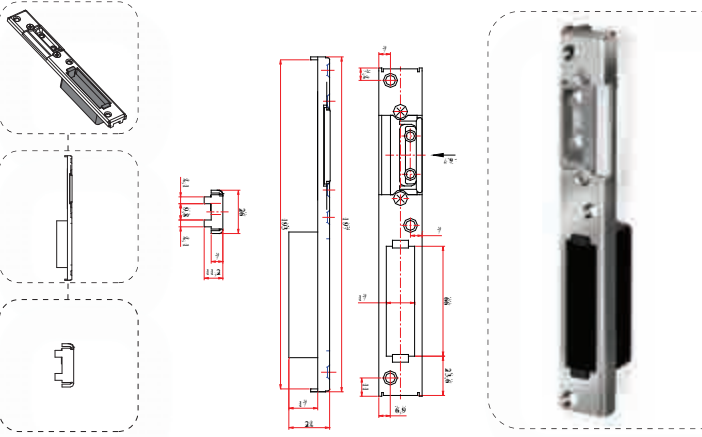

221.004.012.210

Avr Ayarlı Kilit Karşılığı Sağ (9 Aks) 100 

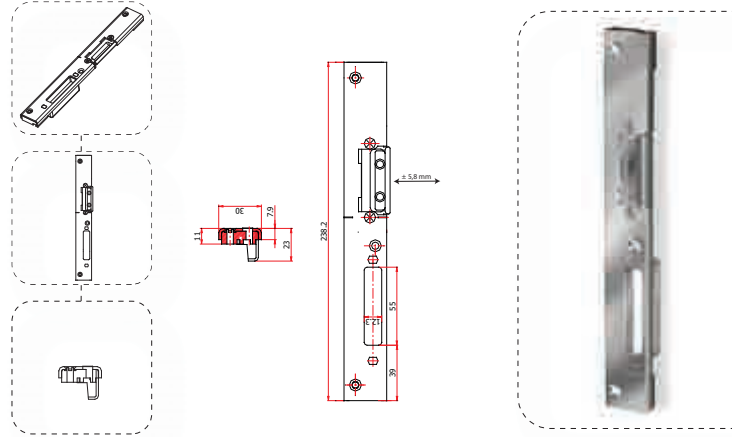

221.004.011.110

Avr Ayarlı Kilit Karşılığı Sol (9 Aks) 250 

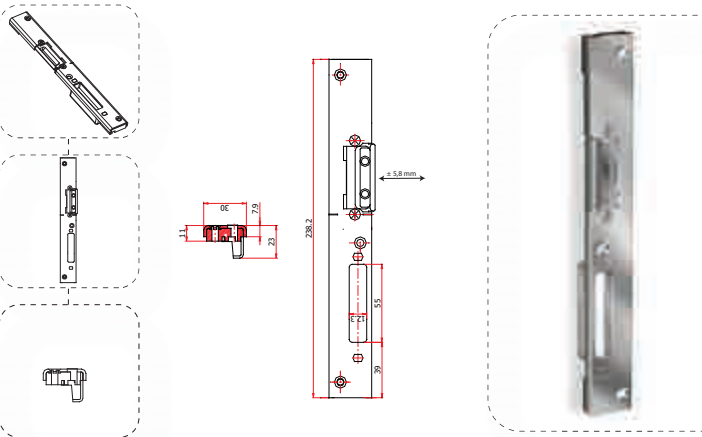

221.004.022.220

Avr Ayarlı Kilit Karşılığı Sağ (13 Aks) 100 

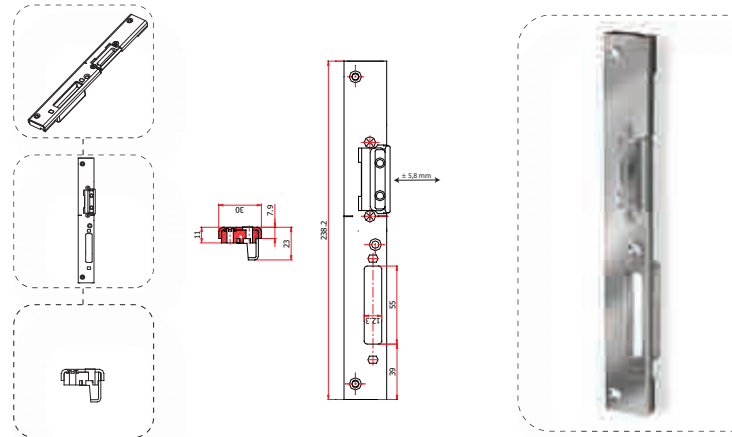

Fornax PvcSecure
Kilit ve Kilitli İspanyolet
Aksesuarları

221.004.021.120

Avr Ayarlı Kilit Karşılığı Sol (13 Aks)

100

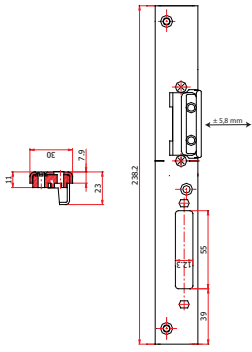
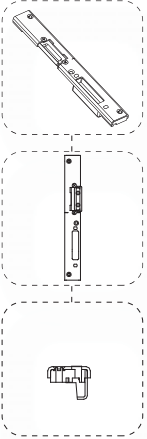

221.002.001.000

Kanca Kilit Dili Karşılığı (9 Aks)

50

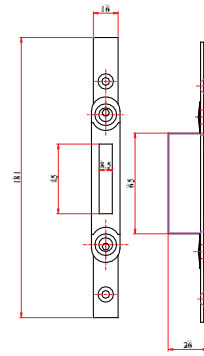
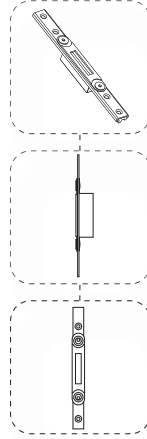

221.002.002.000

Kanca Kilit Dili Karşılığı (13 Aks)

50

